



**REGAL MAGNUM  
PORTABLE OUTDOOR GAS  
BARBECUE**

**INSTALLATION  
INSTRUCTION AND  
OWNER'S MANUAL**



**INSTALLER:** Leave these instructions with consumer.  
**CONSUMER:** Retain for future reference.

**IMPORTANT:** READ THESE INSTRUCTIONS CAREFULLY BEFORE STARTING INSTALLATION OR USE

**SAFETY WARNINGS & CODES**

**⚠ DANGER:**

**IF YOU SMELL GAS:**

1. Shut off the gas to the appliance.
2. Extinguish any open flame.
3. Open lid if equipped with an oven.
4. If odor continues, keep away from the appliance and **immediately** call your gas supplier or fire department.

**⚠ WARNING:**

1. Do not store or use gasoline or other flammable vapors and liquids in the vicinity of this or any other appliance.
2. A propane cylinder not connected for use shall not be stored in the vicinity of this or any other appliance.

**CODE AND SUPPLY REQUIREMENTS:** This barbecue must be installed in accordance with local codes and ordinances, or, in the absence of local codes, with either the latest *National Fuel Gas Code (ANSI Z223.1/NFPA 54)*, and *Natural Gas and Propane Storage and Handling Installation Code (CSA-B149.1)*.

This appliance and its individual shutoff valves must be disconnected from the gas-supply piping system when testing the system at pressures in excess of ½ psig (3.5 kPa).

This appliance must be isolated from the gas-supply piping system by closing its individual manual shutoff valves during any pressure testing of the gas-supply system at pressures up to and including ½ psig (3.5 kPa).

**⚠ WARNING:**

Improper installation, adjustment, alteration, service or maintenance can cause injury or property damage. Refer to this manual. For assistance or additional information, consult a qualified professional installer, service agency, or the gas supplier.

**Certified to ANSI: Z21.58-2005**

All electrical outlets in the vicinity of the barbecue must be properly grounded in accordance with local codes, or in the absence of local codes, with *the National Electrical Code, ANSI/NFPA 70*.

Keep all electrical supply cords and fuel supply hoses away from any heated surface.



**Robert H. Peterson Co.** • 14724 East Proctor Ave. • City of Industry, CA 91746

## CONTENTS

PARTS LIST	3
SIDEburner PARTS LIST	4
ROTISSERIE PARTS LIST	4
BACKburner PARTS LIST	4
WIRING DIAGRAM	5
ELECTRICAL CONNECTIONS	5
OVEN LIGHT	5
BARBECUE SPECIFICATIONS	6
BARBECUE SAFETY INFORMATION & MAINTENANCE	6
PLANNING THE LOCATION OF THE BARBECUE	7
GAS SUPPLY REQUIREMENTS	7
SAFE USE & MAINTENANCE OF PROPANE GAS CYLINDERS	8
INSTALLING THE MAGNUM CART SIDEBURNER SHELF	9
CONVERTING THE GAS SUPPLY	10
CHECKING/CONVERTING THE BARBECUE REGULATOR	10
GAS ORIFICE CHECKING/CONVERSION	11
BURNER AIR SHUTTER ADJUSTMENT	14
SUPPLIED ITEMS	16
BARBECUE CONTROL FACE	16
LIGHTING (IGNITION) INSTRUCTIONS	17
SHUTTING OFF THE GRILL	17
MAGNUM BARBECUING TIPS	18
SETTING AND USING YOUR DIGITAL THERMOMETER	19
ROTISSERIE INSTRUCTIONS	21
USING THE COLLAPSIBLE SHELF	22
USING THE PAPER TOWEL HOLDER	22
ACCESSORIES	23
USING THE GRILL SCRAPER	23
USING THE COOKING GRILL LIFTER	23
DRIP PAN	23
THE FLAVOR GRID(S)	23
WARMING RACK	23
FLAVOR FROM WOOD CHIPS OR CHARCOAL	23
BARBECUE CARE & CLEANING	24
BARBECUE COVER	24
MAGNUM ELECTRICAL MAINTENANCE	25
BARBECUE NOTES PAGE	26
TROUBLESHOOTING	27
FIRE MAGIC OUTDOOR GAS BARBECUES LIMITED WARRANTY	28

## TOOLS REQUIRED

### TOOLS AND SUPPLIES REQUIRED FOR INSTALLATION

- #2 (medium) Phillips screwdriver
- Two medium-size adjustable wrenches
- One pair of pliers
- One flat-blade screwdriver
- \* $\frac{3}{8}$ " wrench or  $\frac{3}{8}$ " socket screwdriver
- Pipe joint compound resistant to all gasses

\*Note:  $\frac{3}{8}$ " socket and a  $\frac{5}{16}$ " socket with a spacer (#6 nut) if gas orifice change is required.

### ILLUMINATING THE GRILL AREA

Your Regal Magnum barbecue is equipped with a set of two lights for illuminating the grill. Press and release the push-button located on the far right of the barbecue face to toggle the lights on or off. The lights shut off automatically when the barbecue lid is closed and come back on again when it is re-opened.

# PARTS LIST

Item No.	Part No.	Description
1.	3544-S-3	Grill. 22" X 10" s.s. rod (Set of 3)
or	3527-5	Porcelain cast iron 22" X 6" (Set of 3)
2.	3057-S	Flavor grid (3)
3.	3041-50	Burners, ser. II s.s. cast (3)
or	3050	Infrared burner (optional)
4.	23739-51	Oven lid
5.	3199-62	Ignitor (6)
6.	24336-15	Drop shelf
7.	3061-S	Zone separators (2)
8.	24393-21	Manifold, portable
9.	3084	Drip tray, assembly
10.	24393-07	Face
11.	3062-S	Wood chip box
12.	3673S-M	Warming rack
13.	3015	Knob, large Fire-Magic (3)
14.	3016	Knob, small Fire-Magic (3)
15.	24187-12	Digital thermometer module
16.	24187-13	Therm. wire, Thermocouple, Battery pack
17.	25387-11	Paper towel holder
18.	24387-11	Electrical junction box
19.	3502	Grill scraper
20.	3519	Grill lifter
21.	PR-4	Regulator
22.	24187-14	Meat probe
23.	5110-15	Two-stage regulator with hose (LP)
or	5110-03	Quick disconnect and 10' hose (natural gas)

**Note:** See next page for backburner, sideburner, and rotisserie parts lists.

To order replacement parts, contact your local Fire-Magic dealer.

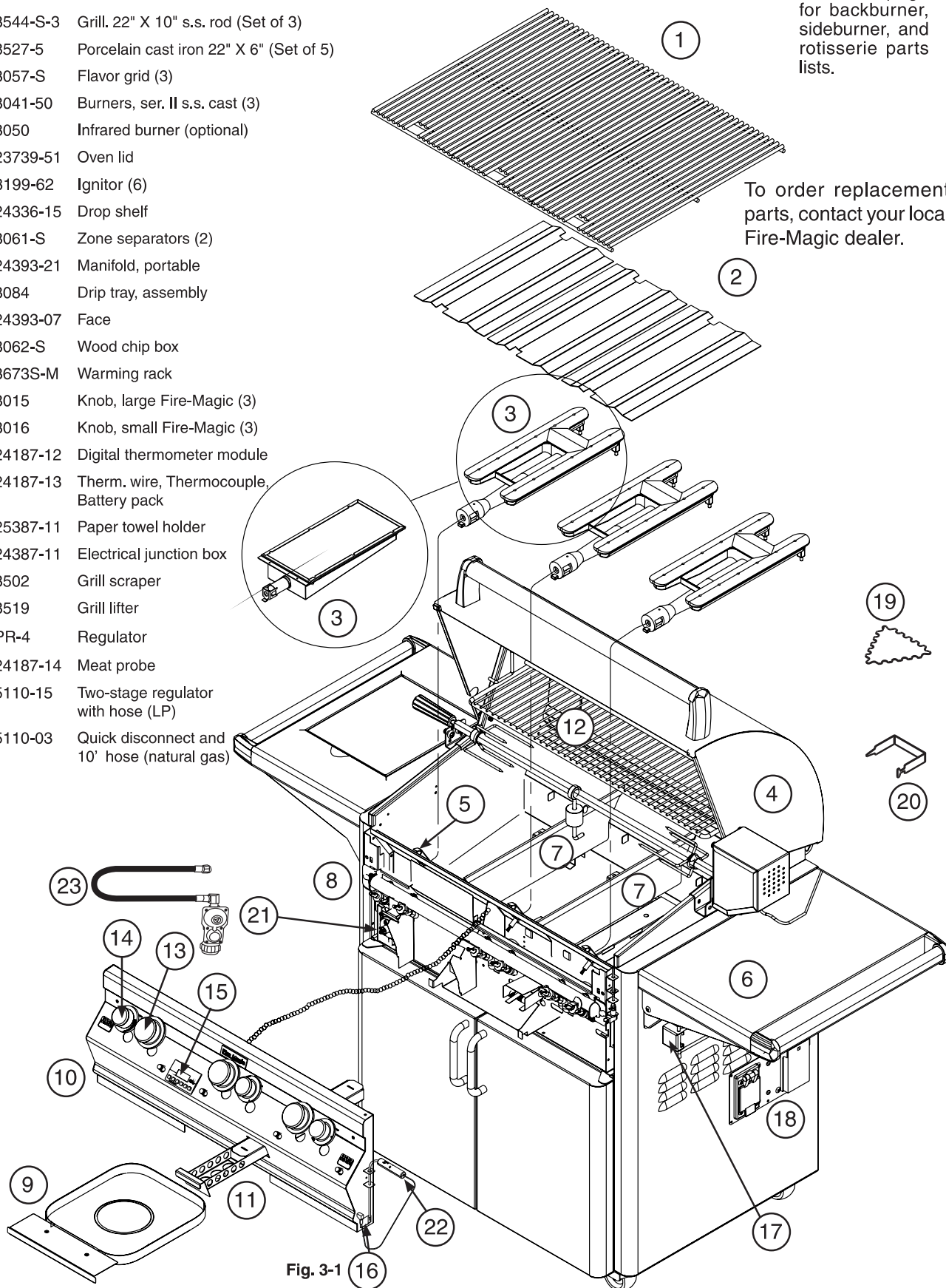

Fig. 3-1

Robert H. Peterson Co. • 14724 East Proctor Ave. • City of Industry, CA 91746

# PARTS LIST (Continued)

## SIDEBURNER PARTS LIST

Item No.	Part No.	Description
1.	24336-31	Sideburner lid
2.	24336-32	Sideburner assembly
3.	3279-36	Sideburner cap
4.	3552	Sideburner grill
5.	3199-62	Sideburner ignitor electrode

Fig. 4-1

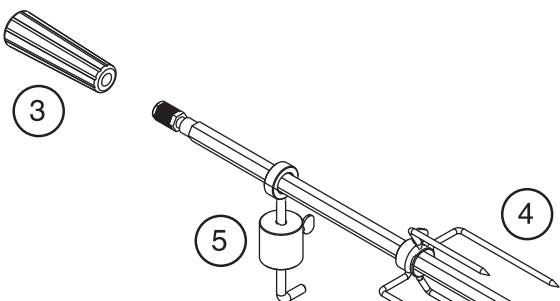
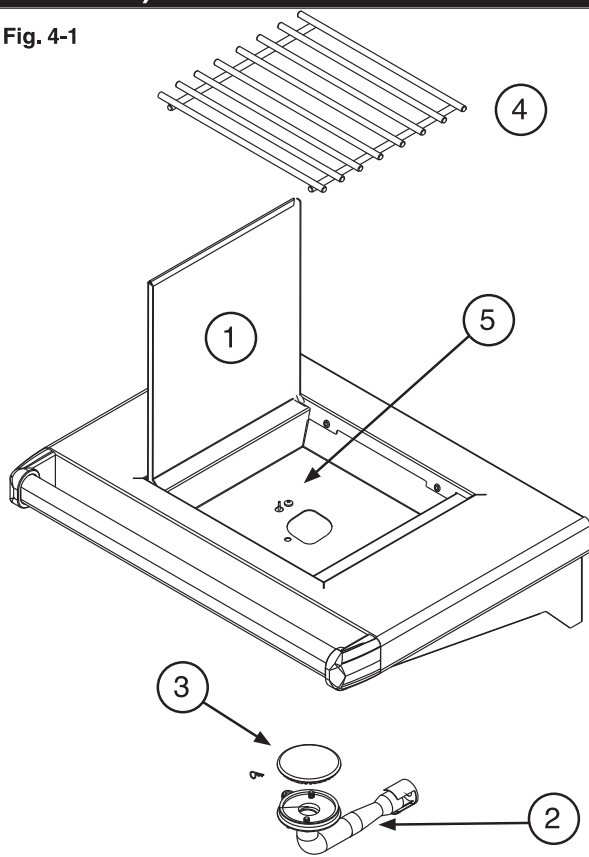

## ROTOISSERIE PARTS LIST

Item No.	Part No.	Description
1.	3600-05M	Heavy duty motor
2.	3606-40	Spit rod
3.	3600-13	Handle
4.	3613	Rotisserie forks (set of 2)
5.	3620E	Counterbalance

Fig. 4-2

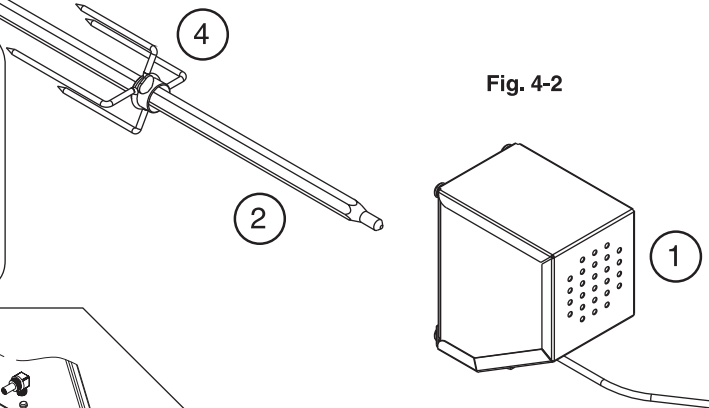
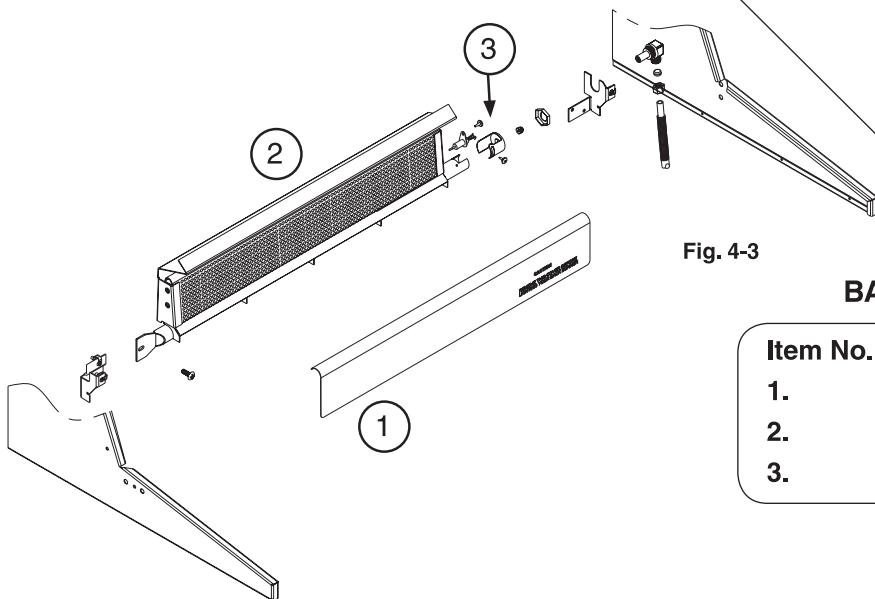

Fig. 4-3



## BACKBURNER PARTS LIST

Item No.	Part No.	Description
1.	24739-010	Backburner cover
2.	24739-02	Backburner assy.
3.	4199-62	Hot surface ignitor

# WIRING DIAGRAM

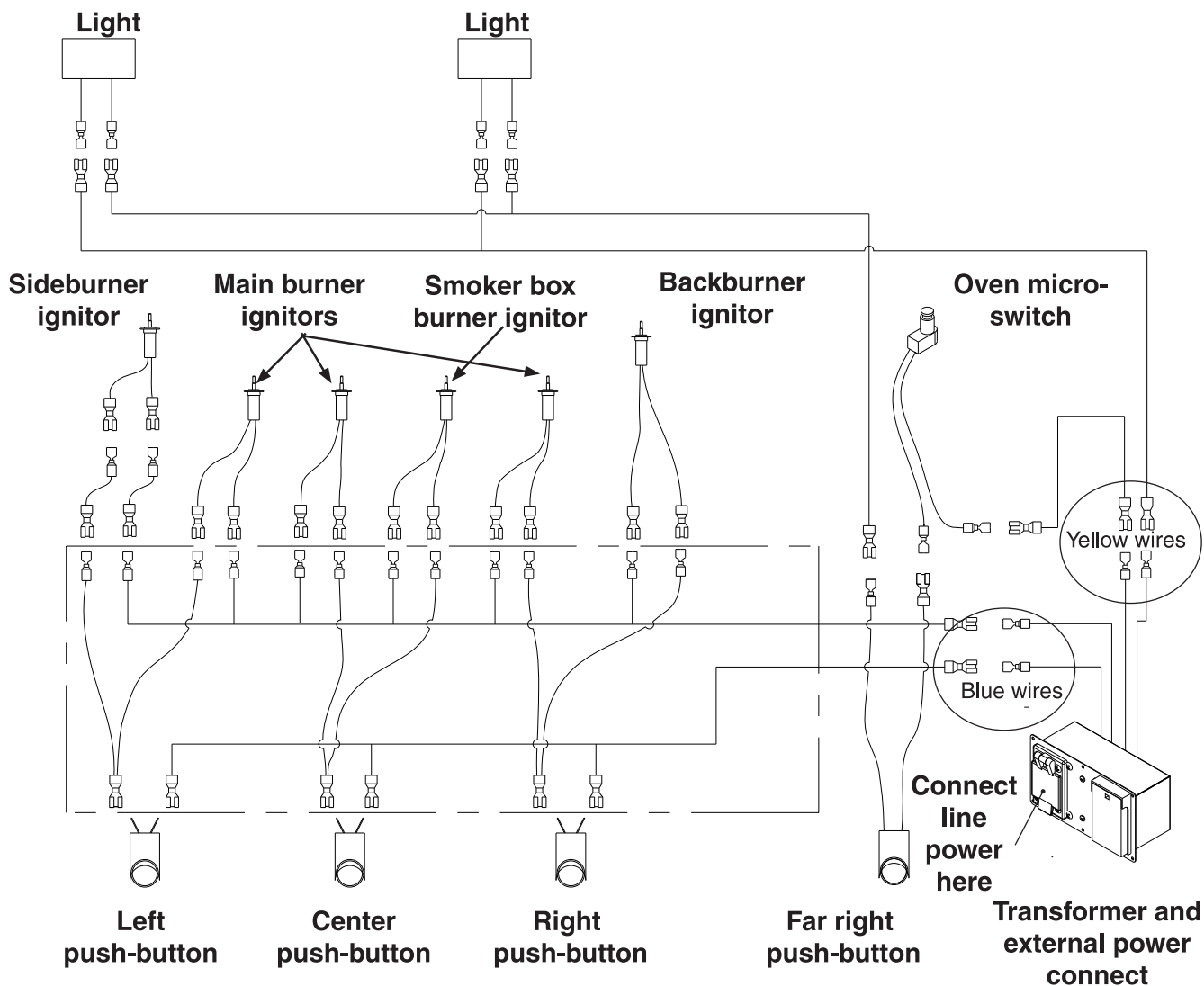

## ELECTRICAL CONNECTIONS

This barbecue utilizes external electrical power for illumination and ignition control.

This means that in order to light your barbecue, it must first be connected to electrical power.

Use a grounded electrical extension cord rated for outdoor use to connect the barbecue to line power.

Plug the male end of the extension cord into an active electrical outlet and the female end into the left-most electrical connector (see SUPPLIED ITEMS list) on the right side of the barbecue. Other electrical devices such as the rotisserie may be plugged into the electrical outlets on the right of the line-power hookup.

## OVEN LIGHT

To turn on the oven lights, open the oven, then push the button on the far right of the barbecue control face (see SUPPLIED ITEMS list) until it clicks.

The lights will automatically turn off when the oven door is closed and then turn on again when it is reopened (much like the light in your refrigerator).

**Note:** A convenient test that electrical power is available for lighting and other functions is to turn on the oven lights. If the lights do not come on, check your electrical connection.

### WARNING

Electrical Grounding Instructions

For your protection against shock hazard, this outdoor-cooking gas-appliance is equipped with a three-pronged (grounding) electrical connector. This appliance should be connected to a properly grounded three-prong receptacle using a grounding extension cord rated for outdoor use. Do not cut or remove the grounding prong from the connector.

## BARBECUE SPECIFICATIONS

### REGAL MAGNUM SPECIFICATIONS

Burner Specifications	Natural	Propane
<b>Main Burner</b>		
BTU per Burner	<b>25,000</b>	<b>25,000</b>
Gas Orifice Size	<b>#42</b>	<b>#54</b>
<b>Backburner</b>		
BTU per Burner	<b>19,000</b>	<b>19,000</b>
Gas Orifice Size	<b>#47</b>	<b>#55</b>
<b>Wood Chip Burner</b>		
BTU per Burner	<b>2,500</b>	<b>2,500</b>
Gas Orifice Size	<b>#68</b>	<b>#77</b>
<b>Sideburner</b>		
BTU per Burner	<b>10,000</b>	<b>10,000</b>
Gas Orifice Size	<b>#53</b>	<b>#63</b>
<b>Infrared Burner</b>		
BTU per Burner	<b>24,000</b>	<b>24,000</b>
Gas Orifice Size	<b>#45</b>	<b>#55</b>
<b>Other Specifications</b>		
Weight	<b>389 lbs.</b>	

Table 1

## BARBECUE SAFETY INFORMATION & MAINTENANCE

**Each time you light this barbecue, make sure that:**

1. The area around the barbecue is clear of flammable substances such as gasoline and other flammable liquids, yard debris, wood, etc.
2. There is no blockage of the flow of combustion and ventilation air through the vent space located below the face of the barbecue.
3. When using propane gas:
  - a. **Keep the ventilation openings in the enclosure free and clear of debris.**
  - b. **Carefully inspect the rubber hose attached to the regulator before each use.**
  - c. **Install the propane cylinder, regulator, and rubber hose in a location not subject to heating above 125° F (51° C).**
4. The burner flames burn evenly along both sides of each burner with a steady flame (mostly blue with yellow tipping). See AIR SHUTTER ADJUSTMENT section. If burner flames are not normal, check the orifice and burner for insects or insect nests.
5. The in-line gas valve or gas cylinder valve is always shut OFF when the barbecue is not in use.
6. The drip collector hole is clear and unobstructed. Excessive grease deposits can result in a grease fire.
7. Do not operate the sideburner with its cover closed, or the backburner with its cover installed.
8. Keep the barbecue free and clear from combustible materials, gasoline, and other flammable vapors and liquids.

**WARNING: NEVER cover the *entire* cooking or grill surface with griddles or pans. Overheating will occur and burners will not perform properly when combustion heat is trapped below the cooking surface.**

**CAUTION: NEVER spray water on a hot gas unit.**

## PLANNING THE LOCATION OF THE BARBECUE

This barbecue is designed **for outdoor use only**.

**DO NOT use this unit under unprotected flammable surfaces. DO NOT use this appliance inside a building, garage, or any other covered area (see EXHAUST REMOVAL). DO NOT use this barbecue in or on a recreational vehicle or boat.**

**Important:** This unit is NOT insulated and therefore the unit, when in operation, must be located with a minimum of 18" (45.7 cm) of side and back clearance from unprotected combustible materials such as wood, plastic, or stucco with wood framing.

The face of the unit is removable for servicing and air shutter adjustment (see PARTS LIST).

### ENSURING PROPER COMBUSTION AIR AND COOLING AIRFLOW

You must maintain proper airflow for the barbecue to perform as it was designed (Fig. 7-1). If airflow is blocked, overheating and poor combustion will result. Do not block the 1" (2.5 cm) front air inlet along the bottom of the face or more than 75% of the cooking grid surface with pans or griddles.

**Note:** The 1" (2.5 cm) front air space allows access to the drip tray.

### ELECTRICAL OUTLETS

All electrical outlets in the vicinity of the barbecue must be properly grounded.

**Note:** Keep electrical-supply cords away from all heated surfaces.

### EXHAUST REMOVAL

If installed or used under a patio roof, the cooking grid area should be fully covered by a chimney and exhaust hood. An exhaust fan with a rating of 1,000 CFM (cubic feet per minute) (472 liters per second) or more may be necessary to efficiently remove smoke and other cooking by-products from the covered area. This barbecue shall not be used under overhead combustible construction. **THIS UNIT SHOULD NOT BE LOCATED IN A FULLY ENCLOSED AREA OF ANY KIND.**

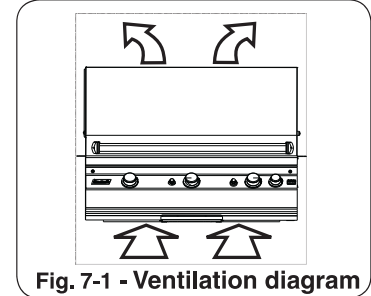

## GAS SUPPLY REQUIREMENTS

### GAS SUPPLY PLUMBING REQUIREMENTS

For natural gas or a household propane system. Rigid 1/2" (1.3 cm) or 3/4" (1.9 cm) black steel pipe, or local code approved pipe, is required to conduct the gas supply to the unit. An outdoor-approved flexible connector can be used to connect the household gas supply to the barbecue. **DO NOT use a rubber hose within the barbecue enclosure, except one specifically designated for this appliance by the manufacturer.** Apply only joint compounds that are resistant to all gasses on all male pipe fittings. Make sure to tighten every joint securely.

**Note:** If 1/2" (1.3 cm) pipe is used with **natural gas**, it should be no longer than 20' (6.1 meters).

**Important:** An external valve (with a removable key) in the gas line is necessary for safety when the barbecue is not in use. It also provides for convenient maintenance.

Natural gas carts are supplied with a quick-connect hose (also available for household propane); see Fig. 7-2.

The quick-connect coupling must be installed after a gas shutoff valve. The coupling socket requires a 1/2" male pipe nipple from the gas supply.

### To Connect

1. Pull socket sleeve back (Fig. 7-3).
2. Insert plug and release sleeve.
3. Push plug into socket until sleeve snaps forward.
4. Open gas valve.
5. Test for leaks using soapy water solution.

### To Disconnect

1. Close the shutoff valve.
2. Pull sleeve back and pull out plug (Fig. 7-4).

### GAS SUPPLY AND MANIFOLD PRESSURES

For **natural gas** - Normal 7" water column (w.c.), minimum 5" w.c., maximum 10-1/2" w.c.

For **propane gas** - Normal 11" w.c., minimum 8" w.c., maximum 13" w.c.

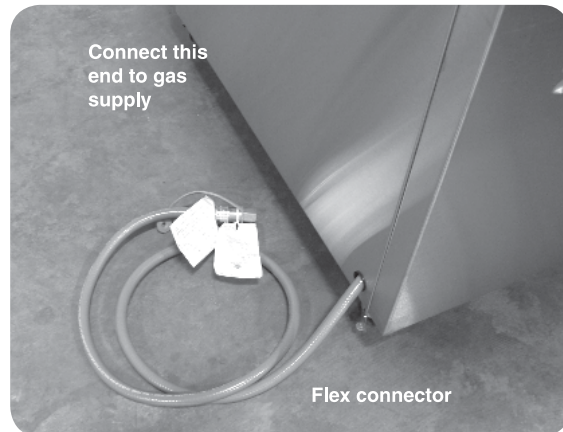

Fig. 7-2 - Natural gas outdoor connector

### Quick-disconnect operation

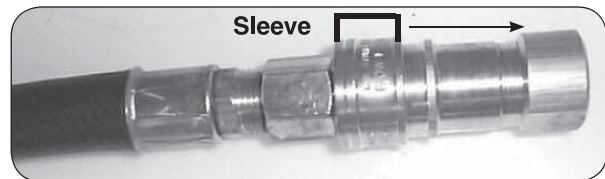

Fig. 7-3 Pull sleeve back

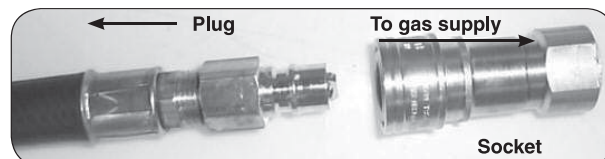

Fig. 7-4 Pull out plug

# SAFE USE & MAINTENANCE OF PROPANE GAS CYLINDERS

## IMPORTANT FOR YOUR SAFETY

### READ AND FOLLOW ALL WARNINGS PROVIDED WITH THE PROPANE GAS CYLINDER.

When operating this appliance with a propane gas cylinder, these instructions and warnings **MUST** be observed.

**FAILURE TO DO SO MAY RESULT IN A SERIOUS FIRE OR EXPLOSION.**

## CYLINDER/CONNECTOR REQUIREMENTS

- Propane gas cylinders, valves, and hoses must be maintained in good condition and must be replaced if there is visible damage to either the cylinder or valve. If the hose is cut or shows excessive abrasion or wear, it must be replaced before using the gas appliance (see e.).
- This barbecue, when used with a cylinder, should be connected to a standard 5-gallon (20 lb.) propane gas cylinder equipped with an OPD (Overfill Prevention Device). The OPD has been required on all cylinders sold since October 1, 1998, to prevent overfilling.
- Cylinder dimensions should be approximately 12" (30.5cm) in diameter and 18" (45.7cm) high. Cylinders must be constructed and marked in accordance with the *Specifications for Propane Gas Cylinders of the U.S. Department of Transportation (D.O.T.)* or the National Standard of Canada, *CAN/CSA-B339, Cylinders, Spheres, and Tubes for Transportation of Dangerous Goods*.
- The cylinder must include a collar to protect the cylinder valve and the cylinder supply system must be arranged for vapor withdrawal.
- The pressure regulator and hose assembly (Fig. 8-1) supplied with this outdoor cooking gas appliance must be used. Original and replacement pressure regulator and hose assemblies must be those specified by the Robert H. Peterson Co. for connection with a cylinder connecting device identified as Type I by the *ANSI Z 21.58-2005/CGA 1.6-2005* (see PARTS LIST for ordering information).
- The propane gas cylinder valve must be equipped with a cylinder connection coupling device, described as Type I in the standard defined in paragraph e. above. This device is commonly described as an Acme thread quick coupler.
- If the propane gas cylinder comes with a dust plug, place the dust cap on the cylinder valve outlet whenever the cylinder is not in use.

## QUICK COUPLER OPERATION

**To connect the regulator/hose assembly to the propane gas cylinder valve fitting:** Press the hand nut on the regulator over the Acme thread fitting on the cylinder valve. Turn the hand nut clockwise to engage the threads and tighten until snug.

The use of pliers or a wrench should not be necessary. Only cylinders marked propane may be used.

**To disconnect:** Turn the hand nut counterclockwise until detached (Fig. 8-1).

**Important:** Before using the barbecue, and after each time the cylinder is removed and reattached, check the hose for wear (see a.) and check all connections for leaks. Turn off the barbecue valves and open the main cylinder valve, then check connections with soapy water. Repair any leaks before lighting the barbecue.

**CAUTION:** Always turn the propane cylinder main valve off after each use, and before moving the barbecue and cylinder, or disconnecting the coupling. This valve must remain closed and the cylinder disconnected while the appliance is not in use, even though the gas flow is stopped by a safety feature when the coupler is disconnected.

**Carefully** inspect the hose assembly each time before the gas is turned on. A cracked or frayed hose should be replaced immediately.

If the appliance is stored indoors, the cylinder must be disconnected and removed. **Cylinders must be stored out of doors, out of the reach of children**, and must not be stored in a building, garage, or any other enclosed area.

## FOR YOUR SAFETY

- DO NOT store a spare propane gas cylinder under or near this appliance.
- NEVER fill the cylinder beyond 80 percent full.
- IF THE INFORMATION IN "a" AND "b" IS NOT FOLLOWED EXACTLY, A FIRE CAUSING DEATH OR SERIOUS INJURY MAY OCCUR.

Fig. 8-1 Type I Acme thread quick coupler

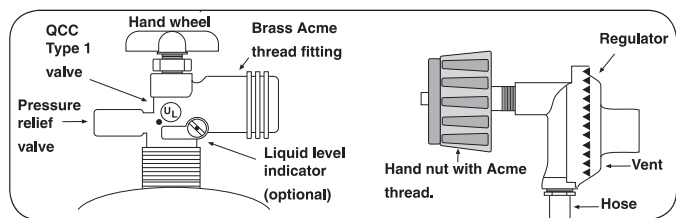

## SECURING THE PROPANE GAS CYLINDER

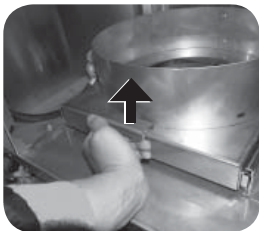

Fig. 8-2

1. Lift latch handle to unlock tray and pull outward.

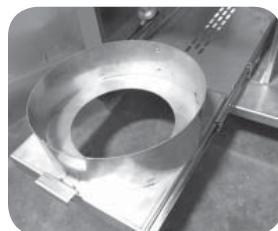

Fig. 8-3

2. Set propane gas cylinder into the sleeve of the extended tray with base inserted into center hole and collar opening to back. Follow instructions above to connect supply.

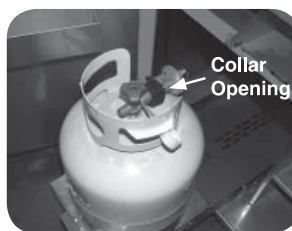

Fig. 8-4

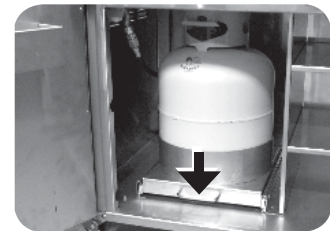
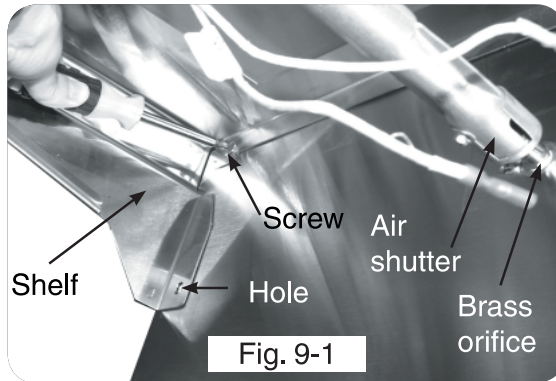

Fig. 8-5

3. With gas cylinder in place and connected, slide tray back into cart and lock latch handle by pushing firmly downward.



## INSTALLING THE MAGNUM CART SIDEBURNER SHELF



Air-shutter orifice placement - under shelf

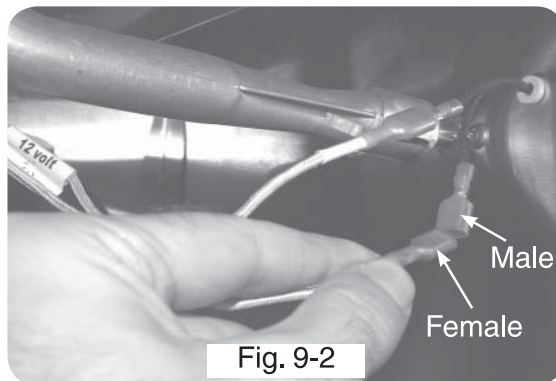

Connecting the ignitor wires

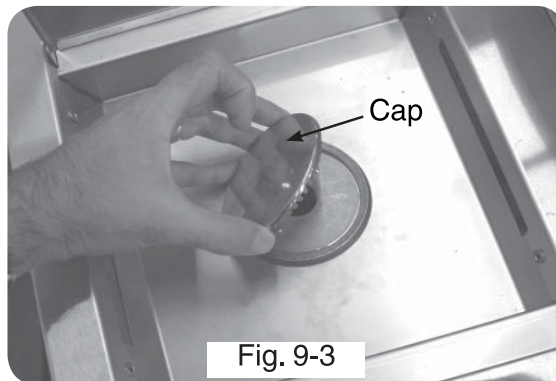

Placing the burner cap

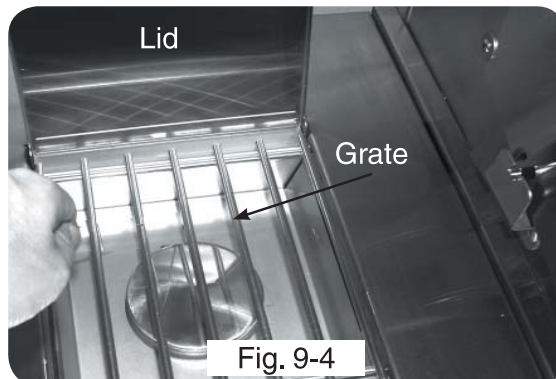

Final look

This shelf comes separate from the barbecue for convenience in shipping. The sideburner shelf must be installed using the following instructions before hooking the barbecue to a gas source.

### INSTALLING THE SIDEBURNER SHELF

**CAUTION:** These instructions must be followed before using the barbecue. If the unit is connected to a gas source, isolate the barbecue from the gas source and turn all valves to the OFF position before beginning this procedure.

1. Hold the sideburner shelf up against the left side of the barbecue so that the holes in the shelf line up with the four (4) threaded screw holes in the side of the barbecue and the air-shutter end of the sideburner manifold fits around the brass orifice protruding from the side of the cart.

**Important:** It is critical for safety and for the function of the burner that the sideburner manifold with air shutter be centered around and completely cover the gas orifice.

2. Insert and start screws with fingers and then tighten using a nut driver, wrench, or ratchet.

**Note:** Upon completion the air shutter must still fit around the brass orifice.

3. Connect the female connectors on the ends of the hot surface ignitor wires to the male connectors coming from inside the barbecue.
4. Place the burner cap on top of the burner, as shown in Fig. 9-4.
5. Place the grid so that it rests on the front and back lips of the sideburner opening.
6. Remove the protective plastic from the sideburner and sideburner lids by carefully peeling it off with your fingers. Do not use tools.
7. Proceed to the section on AIR-SHUTTER ADJUSTMENT and complete the installation by adjusting the air shutter. This will also test the sideburner installation.

## CONVERTING THE GAS SUPPLY

This Fire Magic barbecue comes from the factory configured for one type of gas as marked on the label behind the barbecue face plate.

**Converting this barbecue to burn a different type of gas requires a conversion kit from the factory. The professional installer that converts this barbecue to burn a different gas must perform the following functions:**

1. Change replaceable brass gas orifices on each burner (included at original shipping) to match the new gas type (see Table 1).
2. Switch the convertible gas regulator (included at original shipping) to match the new gas type (see below).
3. Natural to propane gas conversions using a tank internal to a portable barbecue require installation of a propane tank holder (not included with conversion kit) for safety and compliance with the ANSI standards referenced on the cover of this document. This tank holder must be purchased separately from the manufacturer.
4. Plumb the unit to the new gas supply.
5. Apply a new label behind the faceplate indicating the new gas the barbecue will burn (included with conversion kit). The label must be applied partly on top of the old label so that it covers the old gas type and ratings information but not the serial number and other unchanged data.

## **WARNING**

**HAZARDOUS OVERHEATING WILL OCCUR IF A NATURAL GAS ORIFICE IS USED WITH PROPANE GAS. IF YOU ARE NOT SURE THE CORRECT ORIFICES ARE INSTALLED, OR IF AN ORIFICE CHANGE IS NECESSARY, REFER TO THE INSTRUCTIONS ON THE FOLLOWING PAGES.**

**CAUTION:** Make sure the barbecue is at a safe temperature and isolated from gas and electrical supplies before beginning the tasks outlined in the following pages.

**CAUTION:** Use adequate hand protection, such as gloves, when handling potentially sharp sheet metal parts.

## CHECKING/CONVERTING THE BARBECUE REGULATOR

### **WARNING**

THIS APPLIANCE REGULATOR IS RATED FOR  $\frac{1}{2}$  PSI MAXIMUM. IF YOUR GAS SUPPLY IS GREATER THAN  $\frac{1}{2}$  PSI, AN ADDITIONAL REGULATOR MUST BE INSTALLED BETWEEN THE BARBECUE AND GAS SUPPLY. SEE SECTION ON *GAS-SUPPLY REQUIREMENTS* FOR PROPER GAS-SUPPLY PRESSURE.

The barbecue regulator, located behind the front panel (face), must be set for the type of gas used to fuel the barbecue. To check the regulator setting, remove the cap in the center of the regulator (Fig. 10-1). Holding the cap vertical (see Fig. 10-2), the letters at the bottom of the plastic stalk should indicate the gas type for which the regulator is currently set up. If the regulator is not set for your gas type, remove the stalk from the cap, invert and replace into center of cap. Replace cap on the regulator, screwing down until snug.

**Barbecue Regulator**  
**Note the cap on top.**

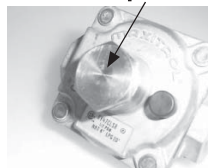
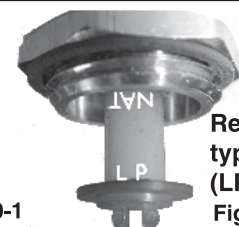

Fig. 10-1



**Read gas type here. (LP shown)**  
Fig. 10-2

## CHECKING/CONVERTING THE BARBECUE GAS TYPE (Cont.)

### GAS ORIFICE CHECKING/CONVERSION

This Fire Magic barbecue comes from the factory configured for one type of gas as marked on the label behind the barbecue face plate.

Each burner has a brass orifice, which can be replaced and must match the gas being used. When converting the barbecue to a different gas, each burner's orifice must be replaced with the corresponding orifice for the new gas.

Consult Table 1 at the beginning of this document to determine the proper orifice sizes for each burner.

It is critical to the operation of each burner that its orifice be fully inserted into the center of its orifice opening.

### WARNING

**Hazardous overheating will occur if a natural gas orifice is used with propane gas. If you are not sure the correct orifices are installed, or if an orifice change is necessary, refer to the following instructions.**

**CAUTION:** Make sure the barbecue is at a safe temperature and isolated from gas and electrical supplies before beginning the tasks outlined below.

For your safety, exercise caution, and make sure you have adequate hand protection, such as gloves, when handling removable sheet metal parts of the barbecue.

### CHANGING THE MAIN BURNER ORIFICES

Suggested tools:

- a pair of needle-nose pliers
- a deep  $\frac{3}{8}$ " nut driver or socket wrench.

1. Remove the grill from above the burner you are working on by lifting it first from the front and set it aside.
2. Remove the flavor grid from above the burner you are working on and set it aside.
3. Remove the cotter pin from the right rear burner anchoring peg by pulling it straight out of the cotter pin hole using needle-nose pliers.

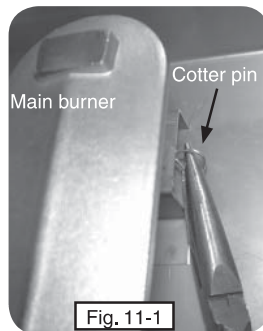

**CAUTION:** The burner is heavy.

4. Lift the back end of the burner out of the anchor peg holes while moving the whole burner toward the back of the barbecue and set it aside.
5. Use the nut driver to remove the exposed orifice (see Fig. 11-2) and replace it with the correct orifice for

the new gas. (See Table 1 at the beginning of this document for correct orifice sizes based on burner type and gas type.)

6. Replace the burner by first sliding the open round end around the orifice and then lowering the back end anchor pegs into the anchor peg holes.

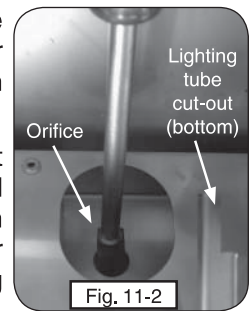

**Note:** It is critical to the continued safe functioning of the burner that the orifice is centered and completely inside the burner gas conduit.

7. Re-insert the cotter pin into the right rear burner anchor peg using needle-nose pliers.
8. Replace the flavor grid and then the grill so that the cutout section of the grill is lined up with the lighting tube.

Repeat these steps for each main burner.

### CHANGING THE BACKBURNER ORIFICE

Suggested tools:

- a Phillips-head screwdriver (#2 medium)
- a  $\frac{3}{8}$ " wrench or socket screwdriver.

1. Remove the warming rack if installed and set it aside.
2. Remove the backburner cover.
3. Unscrew all backburner face plate screws using a Phillips-head screwdriver and set them aside.
4. Remove the backburner face plate by pulling the bottom toward the front of the barbecue and rotating it upward and outward until the two top tabs can be removed from the back wall of the barbecue. Set it aside.
5. Remove the backburner assembly retaining screw on the lower left of the backburner using a Phillips-head screwdriver and set it aside.
6. Pull the backburner assembly to the left, clear of the orifice, and then rotate the top forward and downward and lay it face down across the main burner dividers.

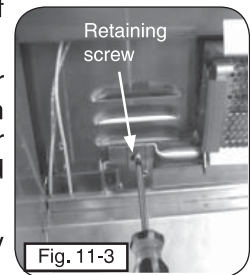

**CAUTION:** Be careful not to damage the wires connected to the backburner assembly.

7. Use the socket with appropriate driver to remove the exposed orifice and replace it with the correct orifice for the gas being converted to. (See Table 1 for correct orifice size for this burner based on gas.)
8. Replace the backburner assembly and re-insert the retaining screw. Center the backburner assembly so that the backburner faceplate will fit over it. Tighten the retaining screw using a Phillips-head screwdriver.

## CHECKING/CONVERTING THE BARBECUE GAS TYPE (Cont.)

- Replace the backburner face plate by first inserting the upper tabs into the slots in the back wall of the barbecue and then rotating the bottom downward and inward.
- Replace all the backburner faceplate screws using a Phillips-head screwdriver.

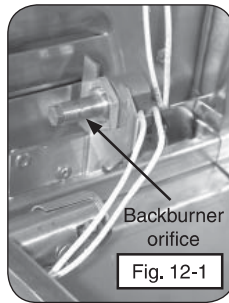

**Note:** It is critical to the continued safe functioning of the burner that the orifice is centered and completely inside the burner gas conduit.

### CHANGING THE FLAVOR DRAWER BURNER ORIFICE

Suggested tools:

- a 1/4" hex nut driver
- a 7/16" wrench
- a 5/8" box wrench

- Remove the burner control knobs from the faceplate by pulling them gently away from the faceplate. Set them aside.
- Pull the flavor drawer completely out of the front of the barbecue and set it aside.

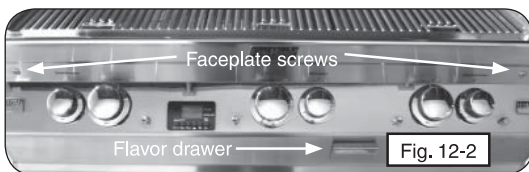

- Release the faceplate from the front of the barbecue by unfastening the screws (Fig. 12-2) on its face with the Phillips-head screwdriver. Then move the faceplate to the right until it clears the "lid closed" switch on the upper right side of the face. Next lift upward and pull outward until the faceplate rests against the internal chain.

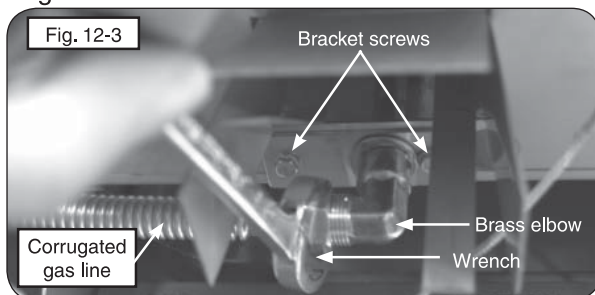

- Locate the flavor drawer orifice bracket behind the faceplate on the right side and remove the compression fitting connecting the corrugated aluminum gas line to the back of the brass elbow projecting out from the bracket using a 5/8" box wrench (Fig. 12-3).

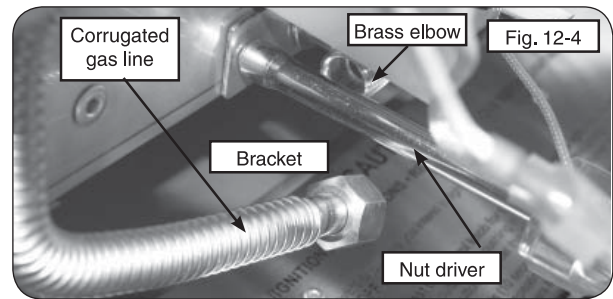

- Remove both hex nut screws from the flavor drawer orifice assembly bracket using the 1/4" nut driver (Fig. 12-4).

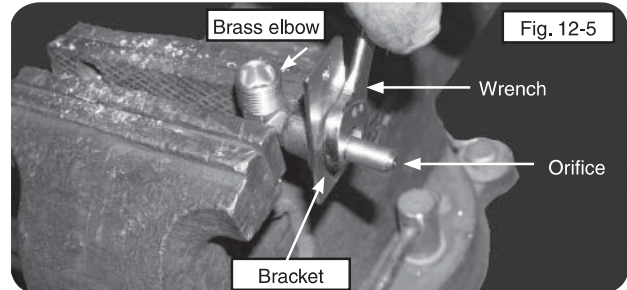

- Remove the bracket and orifice assembly from the barbecue and use two wrenches to loosen the orifice from the elbow. Use a 7/16" wrench with the orifice and a small adjustable wrench or crescent wrench to grip the brass elbow (Fig. 12-5).
- Once the orifice has been removed replace it with the new orifice and re-tighten the orifice assembly with a 7/16" wrench while placing the washers and bracket and elbow in their original positions and orientations.
- Fasten the flavor drawer orifice bracket assembly back into place with the orifice opening pointing toward the back of the barbecue and inserted into the open end of the burner on the other side of the fire wall. Use both original hex nut screws and the 1/4" nut driver.

**Note:** If you bent the metal guides to gain easier access to the hardware bend them back.

- Reconnect the corrugated aluminum gas hose to the brass orifice assembly elbow by re-threading and tightening the compression fitting with the 5/8" box wrench.

**Important:** Check for gas leaks using a soap and water solution. Never test for leaks using a flame.

- Replace the barbecue faceplate and knobs.
- Re-insert the flavor drawer from the front of the barbecue.

## CHECKING/CONVERTING THE BARBECUE GAS TYPE (Cont.)

### CHANGING AN INFRARED BURNER ORIFICE (IF EQUIPPED)

Suggested tools:

- a pair of needle-nose pliers
- a 1/4" hex nut driver
- a 3/8" hex nut driver

1. Remove the grill from above the burner you are working on by lifting it first from the front and set it aside.
2. Remove the lighting tube by removing the two hex nut screws using the 1/4" hex nut driver. Set the screws and tube aside.
3. Remove the infrared burner by lifting the back of the burner up so that both tabs are freed from their slots, then lift the burner toward the back of the barbecue and upward. Set the burner aside.
4. Use the nut driver to remove the exposed orifice and replace it with the correct orifice for the new gas. (See Table 1 for correct orifice sizes based on burner and gas type.)
5. Replace the infrared burner by first sliding it over the orifice, then lining up the two tabs in back of the burner with the two slots in the back of barbecue and lowering them carefully into place.
6. Replace the lighting tube using the 1/4" hex nut driver to lightly tighten both hex nut screws.
7. Replace the grill so that the cutout section of the grill is lined up with the lighting tube.

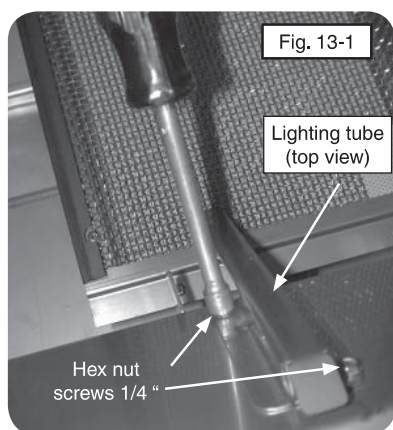

### CHANGING THE SIDEBURNER ORIFICE

Suggested tools:

- a pair of needle-nose pliers
- a 5/16" hex nut driver

**Note:** It may be necessary to remove the rotisserie rod before beginning this procedure.

1. Lift the sideburner lid. Then remove the grill and sideburner cap and set them aside.
2. Locate and remove the cotter pin from the sideburner assembly underneath the sideburner shelf using needle-nose pliers. Set it aside.
3. From the top of the sideburner shelf lift the sideburner upward while rotating the attached tubing underneath away from the orifice near the cart wall. Set it aside.
4. Use the nut driver to remove the exposed orifice and replace it with the correct orifice for the gas being converted to. (See Table 1 for correct orifice sizes based on burner type and gas type.)

**Note:** To protect the manifold threads when placing the new orifice, start the threading manually, and then tighten with the nut driver.

5. Rotate the burner assembly back into place over the orifice and firmly seated in the shelf.
6. Re-insert the cotter pin underneath the sideburner assembly using needle-nose pliers. It may be necessary to push downward on the burner assembly from above to fully expose the cotter pin hole. Rotate the inserted cotter pin so that it is flush with the underside of the shelf.
7. Replace the burner cap by centering it on the sideburner assembly and making sure it drops in place.
8. Replace the grill with the grating running front to back so that it drops fully down onto the shelf, allowing the lid to close completely over it.

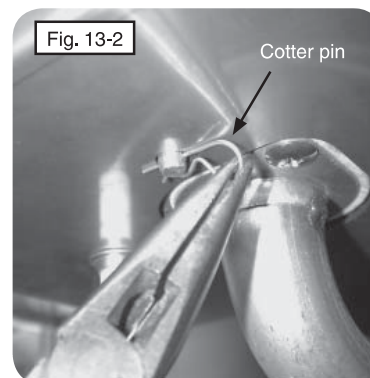

# BURNER AIR SHUTTER ADJUSTMENT

## AIR-SHUTTER ADJUSTMENT

**Important:** Air shutters are preset at the factory based on the gas the barbecue was built to burn. However, altitude or other local conditions may require air shutter adjustment for proper combustion.

## MAIN BURNER

Flames from a properly adjusted main burner with no wind or breeze present will appear fairly steady, consistent, and almost entirely blue. The extreme tips of the flames may be light yellow. If the tip of a flame were to turn orange, it should only do so briefly and then become blue or light yellow again. The flames will appear to burn while touching the burner ports (see Figure 14-1).

If the flames have orange in them and appear to undulate slowly from side to side, or if some of them appear to lift off the burner instead of touching it then adjust the air shutter, as instructed below.

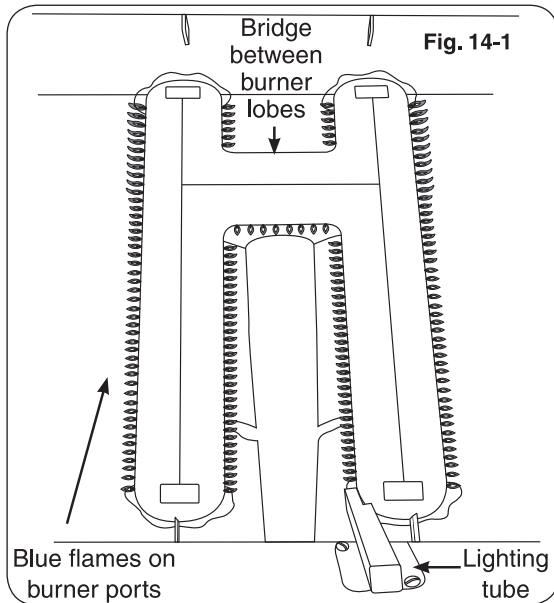

**CAUTION:** Turn all burner control knobs to the **OFF** position and turn off the gas supply at the source before removing or adjusting a burner.

### **WARNING**

Wait for the burner to be cool or use heavily insulated heat-resistant gloves when handling the burner.

1. Follow the safety precautions and steps for main burner removal on the preceding pages (steps 1-5) in the **CHANGING THE MAIN BURNER ORIFICES** section.

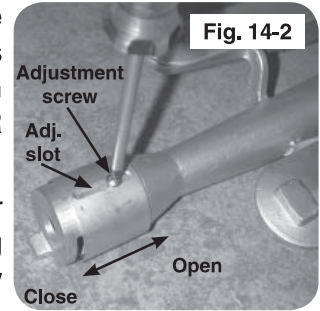

2. Adjust the air shutter opening by loosening the adjustment screw with a screwdriver, then sliding the air shutter backward or forward to open or close the air shutter opening (See Fig 14-2).

Shutter Setting	Flame Condition
Open too far	Flames shorten and lift off the burner
Ideal setting	Blue flames just touching burner (May have light yellow tips)
Closed too far	“Lazy” flames with orange in them

Too large an air-shutter opening will allow too much air into the burner which will cause the flames first to shorten and then to appear to lift up off the ports. For the bottom of the flames to move closer to the ports, close the air shutter more.

If the air-shutter opening is too small or closed, the flames will present consistently orange tips and become “lazy”, slowly undulating back and forth.

For propane gas, ideal settings tend to be just barely open. For natural gas, which generally requires less primary air than propane, the main burner air shutter may even be completely closed.

3. Adjust the air-shutter opening and then replace the burner (steps 7-8 in the **CHANGING THE BACKBURNER ORIFICES** section)
4. Follow the lighting instructions in this manual to light the burner.
5. Repeat steps 1-4 until the flames appear to touch the burner ports, burning fairly steady, consistent, and almost entirely blue with occasional light yellow tips (see Fig. 14-1).

## BURNER AIR-SHUTTER ADJUSTMENT (Continued)

### BACKBURNER

Flames from a properly adjusted backburner will appear as a horizontal line of even blue flames along the bottom of and behind the backburner grating. The grating itself will glow red after it heats up.

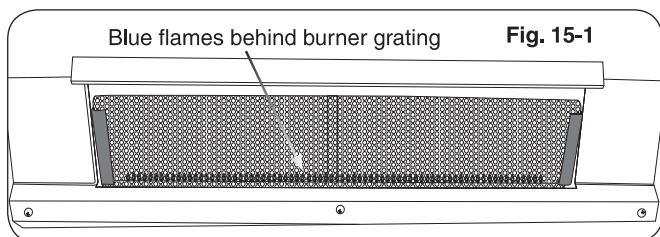

**IMPORTANT:** It is normal for the backburner to smoke when it is burned for the first time. Burning the backburner on **HI LIGHT** for approximately 15 minutes will eliminate the smoking.

If, instead of being blue and even, the backburner flames appear to have orange in them and waver slowly left and right, or if the flames appear to lift off the burner, adjust the back burner air shutter by following the steps below.

The backburner air-shutter adjustment is located behind the right side of the access panel in the back of the oven, above the cooking grid.

**Note:** It is only necessary to remove the backburner access plate, not the backburner, when adjusting the backburner air shutter.

1. Follow the safety precautions and steps for backburner access panel removal (steps 1-4) on the preceding pages in the CHANGING THE BACKBURNER ORIFICES section.

**CAUTION:** The backburner air shutter can be safely adjusted with the backburner lit if it is adjusted using a long-handled screwdriver or well-insulated fire and heat-resistant gloves.

2. Adjust the air-shutter opening by loosening the adjustment screw with a screwdriver, then sliding the air shutter backward or forward to open or close the air shutter opening (See Fig 15-2). Watch the backburner flames while adjusting the air shutter.

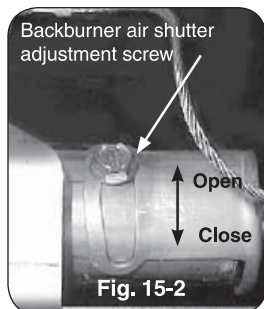

Too large an air-shutter opening will allow too much air into the burner, which will cause the flames first to shorten and then to appear to lift up off the ports. For the bottom of the flames to move closer to the ports, close the air shutter more.

If the air-shutter opening is too small or closed, the flames will present consistently orange tips and become "lazy", slowly wavering left and right.

3. Continue adjustment until the flames appear to touch the burner ports, burning fairly steady, consistent, and almost entirely blue with some light yellow tips; (see Fig. 15-1) then retighten the backburner air-shutter adjustment screw.
4. Replace the burner access plate (step 8 in the CHANGING THE BACKBURNER ORIFICES section).

### SIDEBURNER

The flames from a properly adjusted sideburner will touch the burner ports and appear mostly blue with light-yellow tips.

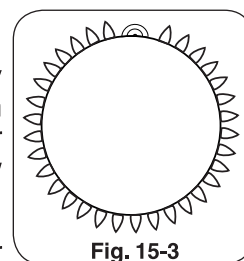

If they are orange, "lazy", or lift off the burner ports, then adjust the sideburner air shutter using the following steps.

Sideburner adjustment is the most accessible (not requiring any hardware to be removed first) and is located underneath the sideburner shelf on the left side of the barbecue, near the wall of the cart. The sideburner air shutter can safely and easily be adjusted while the sideburner is lit.

**CAUTION:** Do not touch the sideburner or the shelf around it. They will be hot while adjusting the sideburner air shutter.

1. Light the sideburner following the lighting instructions in this manual.
2. Loosen the sideburner air-shutter adjustment screw, then use the tip of the screwdriver to open or close the air shutter until the flames appear blue and touch the burner ports.
3. Re-tighten the adjustment screw.

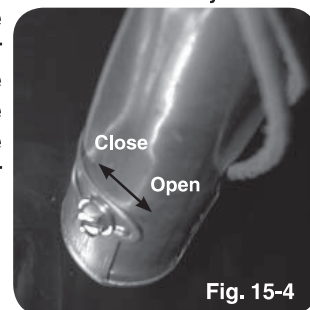

## SUPPLIED ITEMS

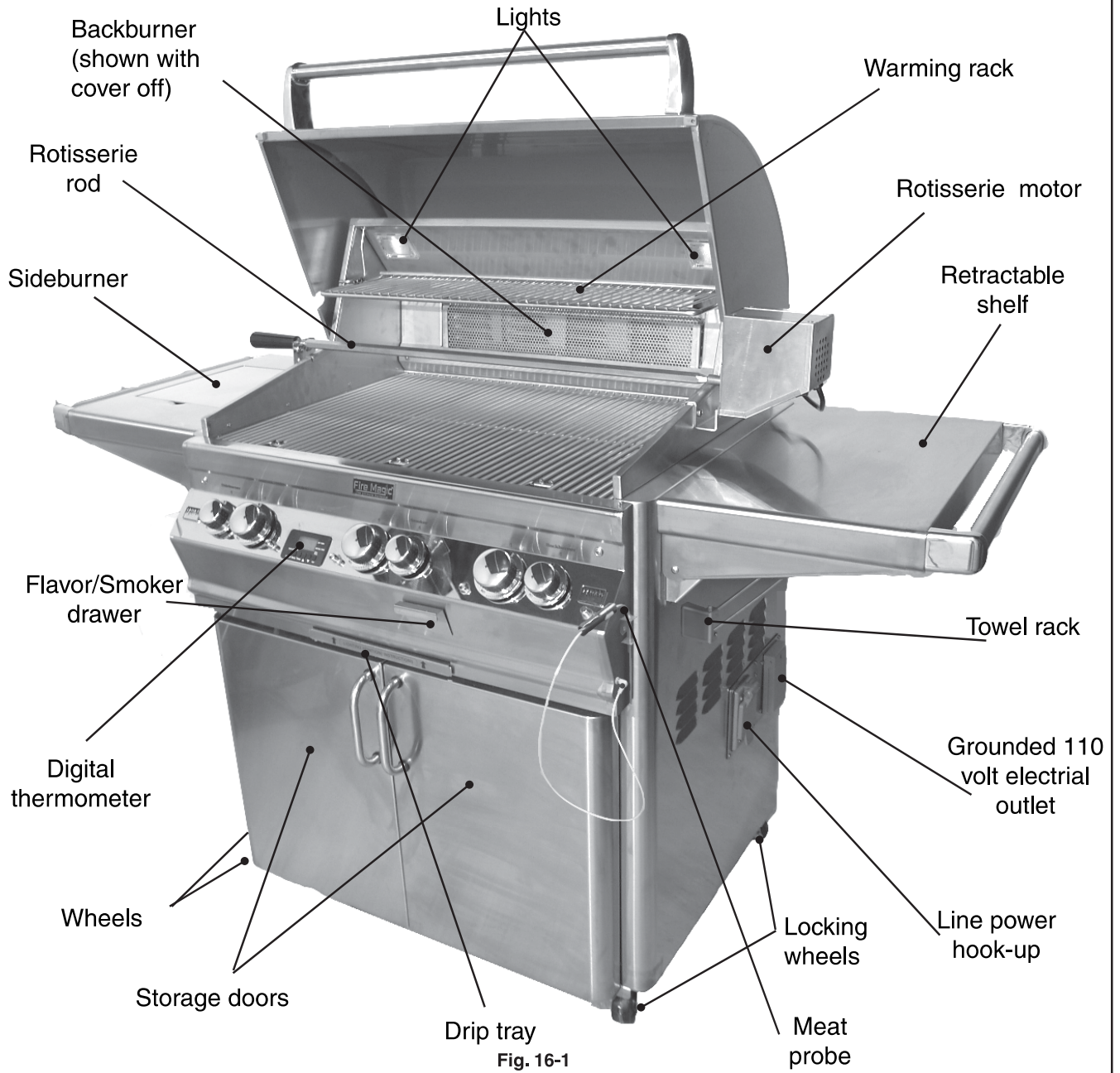

## BARBECUE CONTROL FACE

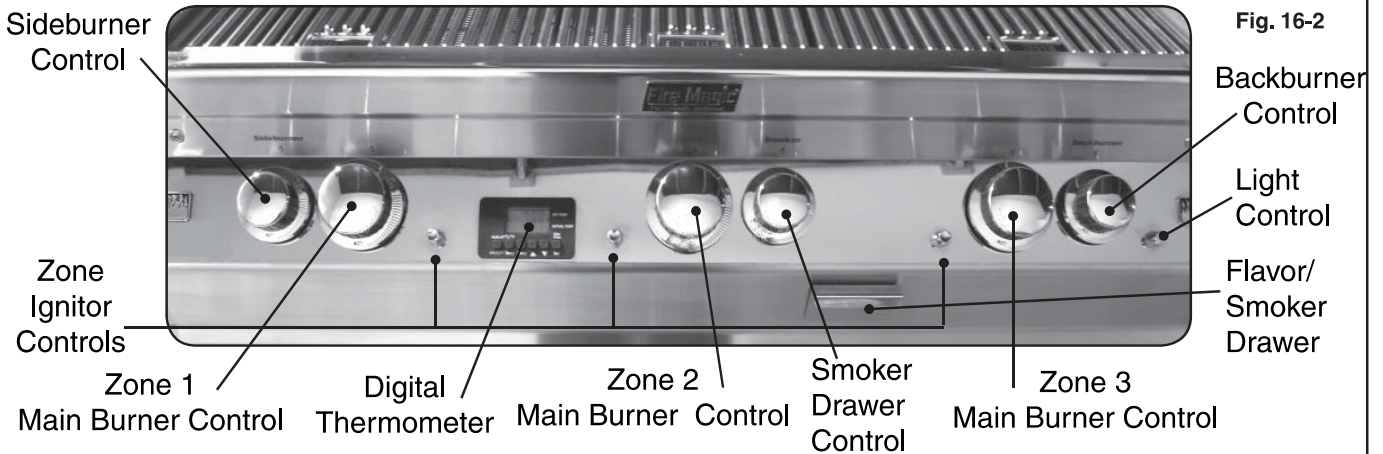



# LIGHTING (IGNITION) INSTRUCTIONS

Read all instructions before lighting and follow these instructions each time you light the barbecue.

## ELECTRONIC LIGHTING

**Note:** Barbecue must be connected to line power for electronic lighting.

1. Open all lids and remove all covers.
2. Turn all gas control knobs to their **OFF** positions.
3. Turn on the gas at its source.

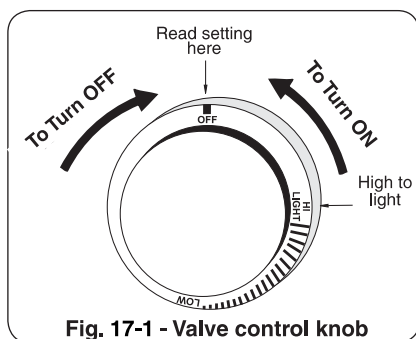

Fig. 17-1 - Valve control knob

**Note:** DO NOT turn on more than one valve at a time for either electronic or manual lighting.

4. Press and hold the ignitor button nearest the control knob for the burner to be lit. Continue to hold in the ignitor button for 5 seconds. The tip of the ignitor will glow orange. Keep holding the ignitor button while depressing the control knob and turning the knob to the **HI LIGHT** position. Once the burner lights, release the ignitor button.

**CAUTION:** If the burners do not light within 5 seconds of turning on the control knob, depress the knob and turn it to the **OFF** position. **WAIT 5 MINUTES** before repeating step 4. If you smell gas, follow the instructions on the cover of this manual. If the burners still do not light after several attempts, refer to the instructions for manual lighting.

5. Repeat step 4 for each additional burner to be lit.

**Note:** Barbecues in some installations will ignite more quickly if the valve is first turned beyond **HI LIGHT** toward **LOW** for lighting.

**Important:** When lighting the burner under the flavor/smoker drawer, first remove the drawer so that the burner can be easily seen. Then replace the drawer after the burner is lit.

## FOR PROPANE ONLY

Propane tanks are equipped with a safety shut-down device that may cause low or no gas pressure/flame at the burners if operating and lighting instructions are not followed exactly (See important note in the TROUBLESHOOTING section for more details.)

## ADJUSTING THE FLAME

The large and small knobs on the face of the barbecue control the valves and adjust flame height. The first labelled position is **OFF**, the second **HI LIGHT**, and the third **LOW**. In between the **HI LIGHT** and **LOW** labels are midpoint marks. Flame height can be set anywhere between the **HI LIGHT** and **LOW** settings for all cooking requirements and methods.

Height of the flame **with a valve in LOW position** may be further regulated by means of a small adjusting screw in the center of the valve stem. This screw is accessible by removing the valve knob, which pulls straight off the end of the valve stem.

## MANUAL LIGHTING

**CAUTION:** Always wait 5 minutes for gas to clear after any unsuccessful lighting attempt.

1. Follow steps 1 through 3 (left).
2. Insert either a burning long-barrel butane lighter or a burning long-stem match through the cooking grids to the top of the lighting tube. (Fig. 17-2). For backburners, hold the flame against the perforated material of the backburner. For sideburners, hold the flame against the burner.
3. While holding the match or lighter flame next to the burner or the top of the lighting tube, depress the appropriate valve knob and turn it counterclockwise to the **HI LIGHT** position. The burner will light.
4. If the burner does not light, **immediately depress the knob and turn the valve to OFF**. **WAIT 5 MINUTES** before repeating steps 2 through 4 of the **MANUAL LIGHTING** instructions.

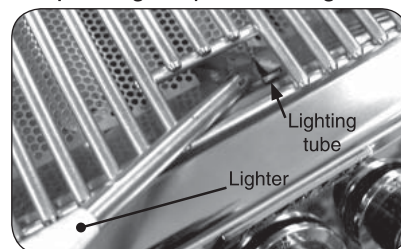

Fig. 17-2 - Manual lighting

**REMEMBER:** FOR SAFE MANUAL LIGHTING, PLACE A BURNING MATCH OR BUTANE LIGHTER BESIDE THE BURNER OR TOP OF LIGHTING TUBE - **THEN TURN ON THE GAS** (see Fig. 17-2).

## SHUTTING OFF THE GRILL

To shut off the grill, push in each valve control knob and turn it clockwise to the **OFF** position.

Always close the valve to the gas supply after each use of the barbecue.

## MAGNUM BARBECUING TIPS

The art of barbecuing involves learning the nuances of your barbecue and knowing how various cuts of meat and other foods cook on it under different settings and conditions.

Each barbecue will be unique due to its configuration and how it is positioned or installed. This section contains information about how magnum barbecues were engineered, which will help you in learning how your barbecue responds to the way you use it.

### COOKING ZONES

Your barbecue is divided into three cooking zones, each corresponding to a main burner. Burners are numbered starting at one (1) on the left going to three (3) on the right (see Fig. 18-1).

Each cooking zone, is designed to be controlled individually. There will be some sharing of heat between zones but overall heat will tend to reduce slightly at the zone borders.

Specific zones are better suited to specific types of cooking, because of features such as being adjacent to a fire wall or away from the smoker flavor drawer.

### GRILL HEAT DISTRIBUTION - MAIN BURNERS

The heat level at each part of the grill has been engineered for specific purposes. Knowing the heat distribution for each burner will allow you the best possible food positioning when grilling.

**CAUTION:** Even the coolest part of the grill is too hot to be touched during operation of the barbecue.

The front of the grill is designed, for safety reasons, to be the coolest part of the grill. If you look directly down on the grill top, while it is off and cool, you can see this portion of the grill as where the front end of each burner stops and the slope of the inner barbecue fire wall begins. This area also loses heat most rapidly when the oven lid is opened (see Fig. 18-2).

From the front of the grill, the heat rises gradually until just above the burner's front edge, where it rises rapidly to a fairly even temperature reflected by the digital thermometer. The heat continues to rise gradually until it reaches a maximum directly above the place where the two lobes of each burner connect

(see Fig. 18-2). From there to the back of the grill, heat diminishes moderately. This supports the desired temperature for the warming rack and prevents heat from becoming excessive at the back fire wall of the barbecue.

### GRILL HEAT DISTRIBUTION - IR BURNER

Infrared burners are designed for even, searing heat across their whole surface. Because the heat is radiant, it tends to heat the food you are cooking directly without heating the air around it as much as a conventional burner.

### SMOKER BOX USE

When using a single cooking zone with the smoker box, use zone 1. It will minimize burner heat on the flavor drawer and maximize a circulating convection current that will draw the smoke flavor into the food.

### WIND CONSIDERATIONS

Wind direction can have an effect on the barbecue especially with the oven open, for maximum stability and convenience position the barbecue so that the oven opens toward any prevailing wind.

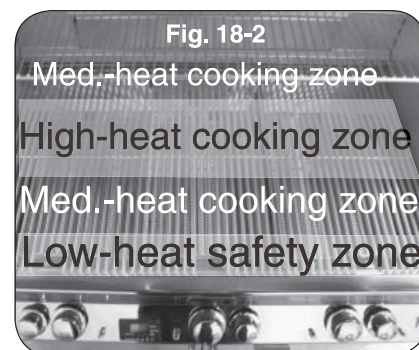
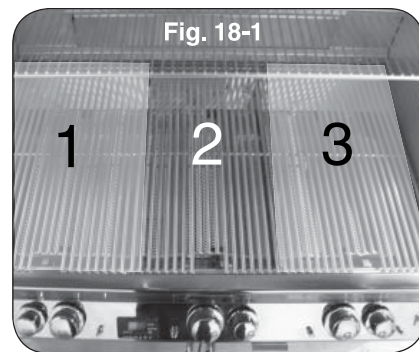

## SETTING AND USING YOUR DIGITAL THERMOMETER

Your barbecue comes with a three (3)-zone digital thermometer with timer.

The thermometer is located on the face of the barbecue between the control knobs for the first and second cooking zones.

### COOKING ZONES

Your barbecue is divided into three cooking zones, each corresponding to a main burner.

Burners are numbered starting at one (1) on the left, going to three (3) on the right. The temperature sensor on each burner has a range of 212-932°F. The meat probe (range 104-212°F) is displayed as zone P in the lower left of the thermometer display.

Temperatures above the upper range are displayed as all dashes.

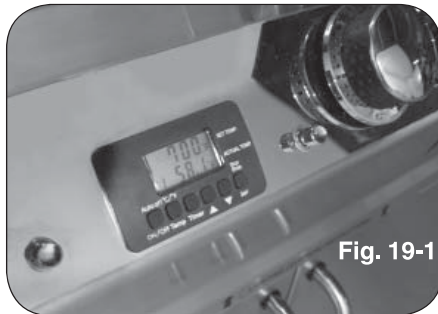

Fig. 19-1

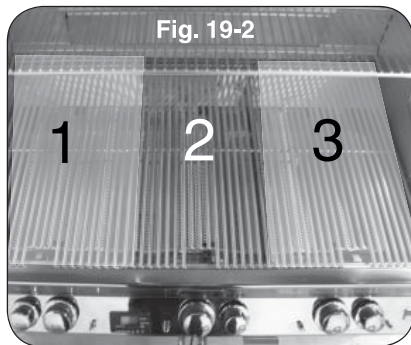

Fig. 19-2

### TURNING THE THERMOMETER ON AND OFF

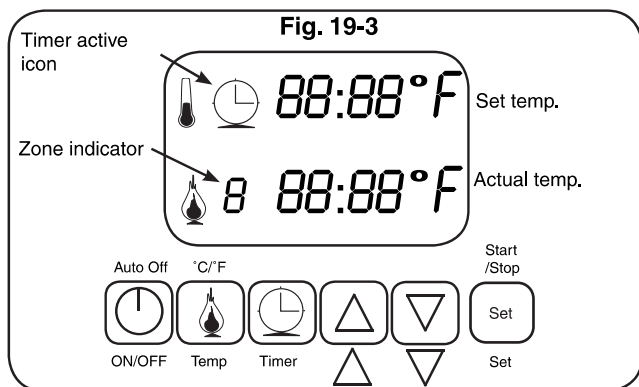



Fig. 19-3

To turn the thermometer on when it is off, or off when it is on, press and release the  ON/OFF button. The thermometer backlight will stay on for 5 seconds after any button is pressed and released.



The thermometer has an automatic shut-off feature that engages after 5 or 10 minutes of low temperature readings.

**Note:** Temperature and timer alarms will not sound when the thermometer is off.

### MONITORING TEMPERATURE

Your thermometer displays the currently set alarm temperature over the current actual temperature (see Fig. 19-3) for one zone at a time. By default the thermometer is in scan mode and will cycle through each of the zones repeatedly. To stop the timer in any one zone, press and

release the **Temp**  button while in that zone. Press **Temp**  again to return to scan mode.

To change the readings from the Fahrenheit scale to Celsius, depress and hold the temperature  button for three (3) seconds until the display blanks (except for either a "C" or "F.") Then use the up  or down  arrow to change the units. Press Temp again to return to temperature monitoring mode. Temperature values will automatically be converted to the new units.

### SETTING THE ALARM TEMPERATURE IN A ZONE

To set the alarm temperature for the currently displayed zone:





1. Press and release the  button.
2. Repeatedly press the up  or down  arrow button to change the value of the blinking digit in the set temperature.
3. Press and release the  button again to make the next digit blink.
4. Repeat steps 2 and 3 until the alarm temperature you wish to set is displayed and the temperature numbers no longer blink. Setting a temperature outside the zone's range will cause ERR to flash on the display.
5. Press the  button again to return to temperature scan mode.







Fig. 19-4

## SETTING AND USING YOUR DIGITAL THERMOMETER (Continued)



**Note:** While the thermometer is scanning through the zones, if the temperature for the currently displayed zone exceeds the set alarm temperature, an audible alarm will sound and the flame icon will flash. No alarm will sound for a zone that is not being displayed.

### SETTING THE TIMER

To set the independent timer alarm, press and release the **Timer** button so that the current timer interval is displayed in H:MM format, where H is hours and MM is minutes.

1. Press and release the  button to select the minutes place. Both digits to the right of the colon will blink.
2. While the digits right of the colon are blinking, press and release the  up/down  arrows repeatedly to change the minutes place. Press and hold to rapidly scan through available values.
3. Press and release the  button again to set the hours place. The digit to the left of the colon will blink.
4. While the digit left of the colon is blinking, press and

release the  up/down  arrows repeatedly to set the hours place. Press and hold to rapidly scan through available values.

5. Press and release the **Timer** button  again to set the timer interval.
6. Press and release the **Set** button  to start the countdown timer. The timer icon will appear indicating the timer has been activated. The timer can be suspended by pressing the **Set** button again while in this mode.

**Note:** When the timer interval has elapsed an audible alarm will sound. Press any button to silence the alarm.

7. Press  again to return to the temperature display.



Fig. 20-1

**Note:** Temperature and timer alarms will not sound when the thermometer is off.

The digital thermometer is powered by two double-A (AA) batteries (included). The battery holder is located on the right side of the faceplate below the meat probe rack and plug. Use alkaline batteries for best results. (Figs. 20-1,20-2)

### REPLACING THE BATTERY

1. Remove the meat probe from its hanger and set it aside.
2. Use your fingernail to pull the top of the battery tray door away from the barbecue.
3. Hold the exposed battery holder tray with two fingers and lift it up slightly at the base so that it lifts up out of the locked position and pulls freely outward.

**Note:** You may now release the battery tray as it will hang out of the barbecue on two stops.

4. Remove old batteries by using a finger to pull the raised (positive) end out of the holder first. Insert new batteries by placing the flat (negative) terminal against the spring and compressing it until the positive end can be pushed into place.
5. Push the battery holder tray back into the barbecue (Fig. 20-1).
6. Push the bottom of the battery holder door in until it locks back into place and the door is once again flush against the side of the barbecue face.

### USING THE MEAT PROBE

The meat probe for zone 'P' of your digital thermometer plugs into the right side of the barbecue faceplate.

1. Plug the mini-jack side of the meat probe into the plug on the right side of the barbecue face (Fig. 20-2 top).
2. Insert the probe into the meat to be monitored.
3. Set the probe temperature as desired, following the digital thermometer instructions.
4. When finished, slide the meat probe into the hanger on the right side of the barbecue face.

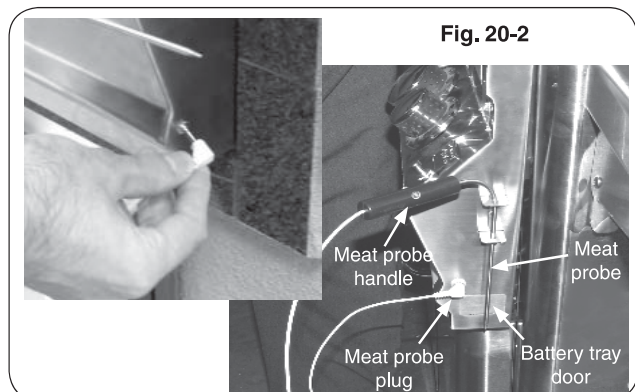

Fig. 20-2

**Important:** Do not put the meat probe directly into flame.

## ROTISSERIE INSTRUCTIONS

### USING YOUR BACKBURNER AND ROTISSERIE

Rotisserie cooking with the backburner is accomplished without use of the main burners. Follow the steps in the appropriate sections below to set up and use these accessories (see PARTS LIST for image).

#### SET UP

1. Remove the backburner cover (if present) by sliding it upward off of the backburner.
2. Remove the cooking grids from your barbecue, if necessary, to obtain maximum clearance for larger cuts. The flavor grids may also be removed if required.

**Tip:** Aluminum foil or a baking pan may be placed over the main burners, a little forward of center, to catch excess drippings from the meat.

3. Attach the rotisserie motor to the rotisserie mounting on the right side of your barbecue by inserting the four mounting tabs through the four holes in the motor mounting on the right side of the barbecue and allowing the unit to slide downward and lock into place.

**Note:** Orient the motor as shown in the PARTS LIST.

4. Follow the LIGHTING INSTRUCTIONS to light the backburner.
5. Allow the backburner to preheat for approximately 10 minutes on **HI LIGHT** setting.

#### PUTTING THE MEAT ON THE SPIT ROD

1. Slide the meat and spit prongs onto the spit rod so the meat is centered and balanced as well as possible.
2. Tighten the spit prongs into place so that the meat remains in a fixed position on the rod and the meat rotates with the rod.

**Important:** The counterbalance, which is included with your rotisserie kit, should be used to balance the load on your rotisserie and prolong the life of your motor. Heavy unbalanced meats can stress the rotisserie motor and may cause motor failure.

#### USING THE COUNTERBALANCE SUPPLIED WITH YOUR ROTISSERIE

1. Hold the spit rod at each end and lift. **Do not grip the rod.** Let the rod rotate so the heavy side of the meat hangs down naturally.

2. Turn the counterbalance on the spit so the counterbalance rod and weight point upward, or opposite from the heavy side of the meat. Tighten the counterbalance rod in the hub against a flat surface of the spit rod to secure (Fig. 21-1).

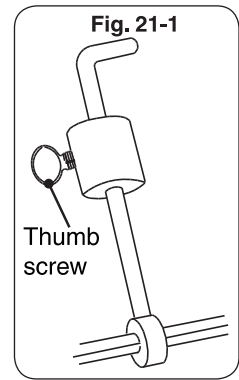

3. Loosen the thumb screw and slide the weight along the counterbalance rod to balance the meat. Since meats are not a uniform shape, it may not be possible to achieve a perfect balance. Properly balanced meat should not rotate when you hold the spit rod loosely by the ends.
4. Make sure the counterbalance will not strike the barbecue frame when the rotisserie is started.

#### RUNNING THE ROTISSERIE

1. Place the pointed end of the spit rod into the motor drive socket and rest the handle end of the spit rod in the spit bracket on the right side of the barbecue.
2. Plug in (if necessary) and turn on the rotisserie motor.
3. Use a standard roasting guide to estimate the length of time for your meat. A meat thermometer may also be used to tell when your favorite cuts are cooked to your liking. When testing temperatures with a thermometer, turn off the rotisserie motor and turn the backburner on **LOW**. This will keep the meat from over cooking on one side.

**Note:** When burning properly the backburner flames will be blue with yellow tipping and the grating will glow red. The first time it is used the backburner may smoke a little.

**Important:** Operate your backburner with the oven closed. This simulates an oven effect and helps your meat cook faster. Constant rotation of the spit assures even cooking and maximum retention of juices.

**Note:** On large cuts of meat or whole turkeys, it may be necessary to reduce the heat from your backburner. Cooking your food at a lower temperature for a longer period of time will keep the outer surface from burning while cooking the interior of your meat. In any case it is normal for the back burner grating to glow red when operating properly.

## USING THE COLLAPSIBLE SHELF

### DROP-SHELF OPERATION

- A.** To lower the shelf, grasp the middle of the shelf on both sides and lift upward so that the inner lip of the shelf, along the side of the barbecue, lifts out of the locking slot. Then use the handle to allow the end of the shelf to slowly rotate down as pictured to the right.
- B.** To raise the shelf, perform the opposite of A. above. Grab the shelf by the handle and raise to the horizontal position. Lift slightly upward from the center of the shelf on both sides, allowing the inner lip to drop down into the locking slot and lock the shelf safely into position.

**CAUTION:** Do **NOT** place fingers near hinge when closing.

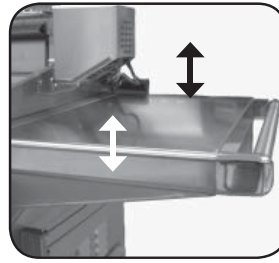

Shelf  
up & locked

Being  
lowered or  
raised



Shelf  
down

## USING THE PAPER TOWEL HOLDER

This Fire Magic barbecue comes with a fold-away paper towel holder.

To use the paper towel holder:

1. Make sure the collapsible barbecue shelf is extended and locked.
2. Grasp the rounded end of the paper towel holder firmly (without compressing it) and pull it away from the side of the barbecue so that it rotates toward the front of the barbecue and locks into the extended position.
3. Slide a roll of paper towels over the rounded end of the paper towel holder until the entire roll is on the holder and past the retaining lip.

When not in use, the rack may be folded back out of the way by firmly grasping the rounded end of the holder and rotating it back into position against the wall of the barbecue.

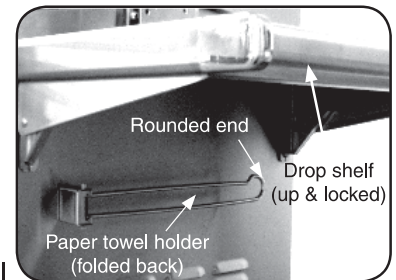

Fig. 22-2

**WARNING**  
Remove paper towels or anything flammable from the holder before folding it back against a hot barbecue. Placing flammable objects too close to a heat source may cause fire, property damage, or injury.

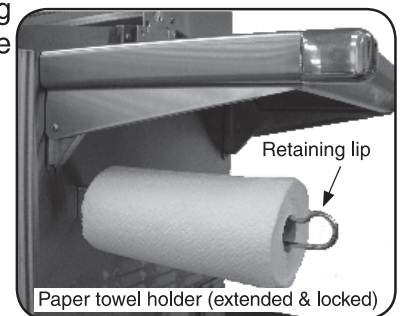

Fig. 22-3

**CAUTION:** The paper towel holder must be folded back against the barbecue before lowering the collapsible shelf (see above). Failure to do so could result in damage to the barbecue.

## ACCESSORIES

### USING THE GRILL SCRAPER

The triangular stainless-steel piece with serrated edges is designed to be used as a tool to quickly and easily scrape food particles and drippings off the grill after barbecuing. To use it, simply align one of the edges of the scraper so that the cooking grid bars fit into the grooves in the serrated edge, and then scrape it along the length of the cooking grid. Repeat as needed.

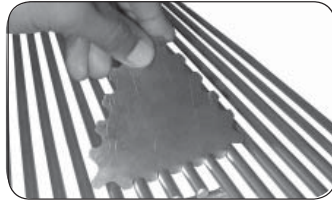

Fig. 23-1  
Grill scraper use

### USING THE COOKING GRILL LIFTER

Hold the grill lifter by gripping the center section with the prongs pointing down (use an oven mitt or heavy glove if the grill is hot). Insert the notched end of the grill lifter into the grill, in front of the midway point (front to back-Fig. 23-3), and central (left to right-Fig. 23-4). Twist the grill lifter (clockwise or counterclockwise) so the handle is parallel to the grill rods. This “seats” the spiked end of the grill lifter between two rods, enabling you to safely lift the grill out of the barbecue. Lift slowly and adjust the grill lifter, if necessary, to balance.

### DRIP PAN

The drip collection system allows you to brush or scrape excess dried residue inside the barbecue directly into the drip pan (see PARTS LIST for drip pan location). To simplify cleanup when using the rotisserie, you may place a baking pan or foil under the rotisserie to collect the drippings. Clean the drip pan after each use.

### THE FLAVOR GRID(S)

Place each flavor grid directly on a burner or burner pair. Center each grid over the burner, oriented as shown in Fig. 23-6.

**Note:** This allows heat from the burners to be evenly distributed throughout the cooking area. The Flavor grids heat and cool quickly, making the barbecue very responsive to the changes in heat from the burners.

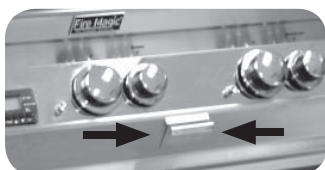

Fig. 23-5  
Wood chip smoker drawer



Fig. 23-6

### WARMING RACK

The warming rack (Fig. 23-2) is packed separately with the barbecue.

To install the warming rack, lift the front of the rack up slightly and insert the rack hangers into the two holes in the back of the barbecue above the backburner. Then lower the front of the rack into a level position to lock the rack in place.

To remove the warming rack, lift up on the front of the rack until the rack hangers pull free from their supporting holes.

**Note:** For best results, remove the warming rack before using the rotisserie.

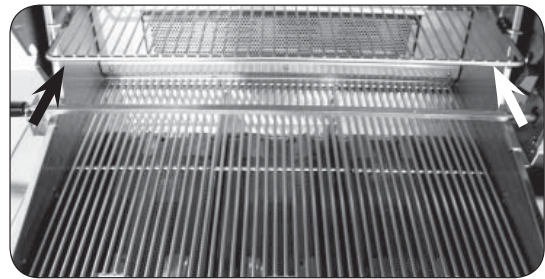

Fig. 23-2 Warming rack in place inside oven



Fig. 23-3

Placement of the grill lifter in grill

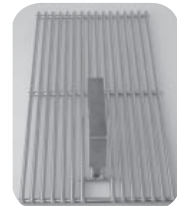

Fig. 23-4

### FLAVOR FROM WOOD CHIPS OR CHARCOAL

You can add wood chips, wood chunks, or the natural wood charcoal of your choice to the flavor drawer (Fig. 23-5) or the flavor grid (Fig. 23-6). Heat wood chips in the flavor drawer by lighting the smoker burner using the smoker control and zone 2 ignitor. When using the flavor grid, we recommend placing wood outside the direct cooking zone or wrapping it in perforated aluminum foil. Soaking wood before use will slow burning and increase smoke flavor. Wood and charcoal ash will remain in the flavor grid and drawer after use. Either can be easily removed and cleaned when unit has fully cooled. The flavor drawer is water-tight, allowing liquid flavorings to be added as well.

## BARBECUE CARE & CLEANING

### CARE AND CLEANING

Your new Fire Magic barbecue represents the latest and most advanced technology available. In order to continue to enjoy the benefits of this technology and to protect your investment, we recommend the following:

Cover your barbecue with a Fire Magic cover when not in use.

Clean the unit with a quality stainless steel cleaner at least once a month (see Fig. 24-1).

**Note:** In a humid environment, due to the nature of stainless steel, iron oxide deposits may appear. Do not be alarmed – these deposits are removable with stainless steel cleaner during periodic maintenance.

Check the burner ports at least annually for blockage by removing the burner (see orifice changing instructions) and visually inspecting the gas intake tube for insects and nests. A clogged tube can lead to a fire beneath the grill.

The inside of the barbecue may be cleaned periodically with oven cleaner if desired. Follow the oven cleaner instructions for proper use.

By following these recommendations, you will enjoy the beauty and power of your barbecue for many years to come.



Fig. 24-1 - Wipe with grain

## BARBECUE COVER

### PROTECTING YOUR BARBECUE

An optional heavy-duty cover will protect the finish on your barbecue and preserve your investment. The water repellent material will shield the barbecue from corrosion and oxidation.

To provide a custom fit, each cover has been cut and sewn by hand for a particular smoke oven model. Make sure to give the model number of your barbecue when ordering a cover from the manufacturer or your local dealer.

To maintain and protect the barbecue cover, occasionally wipe the outside with a sponge soaked

in water and a mild household detergent or cleaner, and rinse with a clean damp cloth.

**Important:** Allow barbecue to cool before covering.

**Important:** Always close the gas supply shut off valve to the barbecue. If storing the barbecue for a long period of time, disconnect the barbecue from the gas supply completely.

Always check the burners after long periods of disuse to look for obstructions that may hamper performance and safe operation of your barbecue.



Fig. 24-2



## MAGNUM ELECTRICAL MAINTENANCE

The Magnum barbecues are all engineered with the conveniences of electrical power. Very little electrical maintenance will ever be required over the life of a properly installed and utilized barbecue.

The light bulbs that come with the Magnum may eventually require replacement.

To replace any Magnum oven light, follow the instructions below.

### **WARNING**

To protect from potentially sharp sheet metal and glass, wear gloves and safety glasses during this procedure.

1. Turn all burner control knobs to the OFF position and shut off the gas supply to the barbecue at the source (tank valve for propane units or gas line shut-off valve for natural gas units.)
2. Shut off the supply of external electrical power to the barbecue.

**CAUTION:** Wait for the barbecue, oven, lens, light bulb, and fixture to cool before proceeding to the next step.

3. Open the oven lid.

**Important:** Place one hand directly below the glass lens and prepare to catch it when it is detached.

4. Carefully insert a standard flat head screwdriver or thin plastic spatula between the glass lens and the stainless steel on which the light is mounted

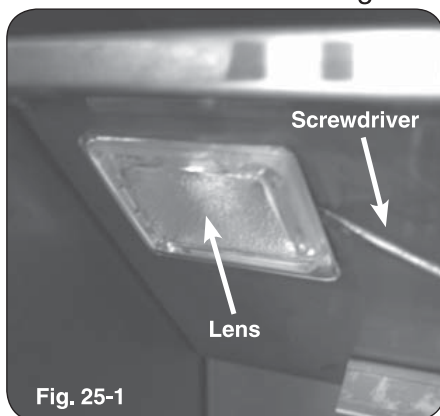

and gently pry the glass lens out in such a way that the stainless steel is not scratched (twisting the screwdriver handle, for instance). Catch the lens and set it safely aside.

**Note:** You may wish to take this opportunity to clean the lens with a standard household window cleaner and then dry it completely.

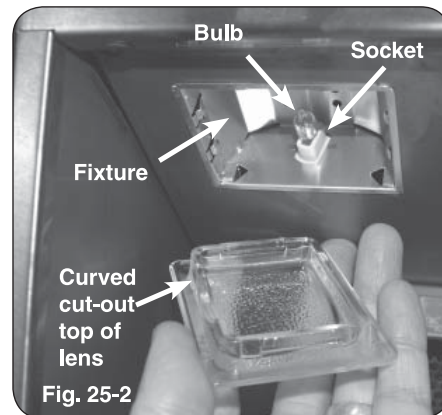

5. Wearing a pair of gloves, reach into the fixture, gently grab the bulb, and pull it straight out of the fixture so that the two pins at the base of the bulb come all the way out.

**Important:** Bulb is halogen. DO NOT TOUCH with bare hands. Oils from hands drastically reduce bulb life.

**Note:** It may be helpful to rock the bulb gently backward and forward while pulling it out.

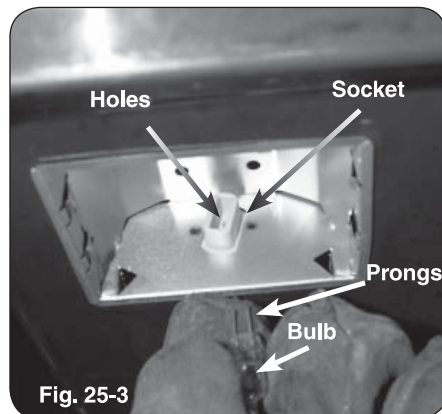

6. Inspect the old bulb for broken glass or filament.

**Note:** It may be beneficial to test a suspect bulb in one of the other light fixtures known to be working and turn the power back on to be certain the bulb is actually not working.

7. Insert the new bulb into the socket so that both pins slide all the way into the two holes in the bottom of the socket.
8. Place the lens back into the fixture opening with the curved cut-out on the top and snap it firmly but gently back into place.

## BARBECUE NOTES PAGE

Please use this page to record any information about your barbecue that you may want to have at hand.

## TROUBLESHOOTING

If you have trouble with this Fire Magic barbecue, please use this list to identify the problem. By trying one or more of the solutions to the possible cause, you should be able to solve the problem. If this list does not cover your present problem, or you have other technical difficulties with the barbecue, please contact your local Fire Magic dealer or visit our web site at [www.rhpeter.com](http://www.rhpeter.com).

PROBLEM	POSSIBLE CAUSE	CORRECTION
<b>Ignition system failure</b>	1. Power source not hooked to barbecue 2. Improper air-shutter adjustment 3. Ignition wire disconnected 4. Low gas pressure	1. Hook external power to barbecue. 2. Adjust air shutters. 3. Plug wires back into ignition switches. 4. Have the gas co. check pressure at barbecue.
<b>Insufficient heat</b>	5. Improper air-shutter adjustment 6. Using propane orifice for natural gas 7. Low gas pressure/flame (propane) 8. Low gas pressure/flame (natural)	5. Adjust air shutters. 6. Check/change orifices. 7. Shut off all valves including propane tank and follow lighting instructions exactly. (See important note* below.) 8. Have the gas co. check pressure at barbecue.
<b>Uneven heating</b>	9. Burner ports partially blocked by debris 10. Small spiders or insects in burner 11. Improper air-shutter adjustment	9. Remove burners and clean out ports. 10. Inspect burners and orifices for spider webs or other debris that may block flow. 11. Adjust air shutter.
<b>Thermometer malfunction</b>	12. Battery charge low	12. Replace batteries.
<b>Rotisserie noisy</b>	13. Rotisserie out of balance	13. Adjust rotisserie counterbalance.
<b>Rotisserie doesn't turn but lights work</b>	14. Elec. socket circuit breaker is tripped	14. Reset circuit breaker (See Fig. 27-1).

**Fig. 27-1**

**Table 2**



**To reset the cart electrical outlets press in hard on the reset (upper) button until you hear an audible click.**

**Note:** The main power feed to the cart must be on for the reset switch to function. Open the barbecue oven lid and turn on the lights to verify that the barbecue has electrical power before resetting the breaker.

**\* Important:** Propane tanks are equipped with a safety shut-down device that may cause low or no gas/flame at the burners if operating and lighting instructions are not followed exactly. If you suspect the propane tank safety shut-off is in effect, shut off all burner control valves and the propane tank valve. Then read and follow the LIGHTING INSTRUCTIONS exactly. Lighting instructions are located in your owner's manual and printed on the barbecue's metal drip tray. If the problem persists, continue troubleshooting, or contact your local dealer or R. H. Peterson for assistance.

# FIRE MAGIC OUTDOOR GAS BARBECUES LIMITED WARRANTY

**PLEASE COMPLETE AND RETURN YOUR REGISTRATION CARD, WHICH IS INCLUDED WITH YOUR BARBECUE**

**LIFETIME WARRANTY** - Fire Magic cast stainless steel burners, stainless steel rod cooking grids, and stainless steel housings (including liners, frames, ovens, and barbecues faces) are warranted for as long as you own your Fire Magic barbecue.

**FIFTEEN YEAR WARRANTY** - Fire Magic cast brass burners, brass valves, backburner assemblies (except ignition parts), manifold assemblies, and porcelain hoods and faces are warranted for 15 years from the date of purchase of your Fire Magic barbecue.

**THREE YEAR WARRANTY** - Fire Magic sideburners and all other Fire Magic barbecue components (except ignition and electronic parts) are warranted for 3 years from the date of purchase of your Fire Magic barbecue.

Fire Magic ignition systems, electronic components (including lights and thermometers), and barbecue accessories are warranted for one year from date of purchase.

**PLEASE KEEP A COPY OF YOUR SALES SLIP FOR PROOF OF PURCHASE**

This warranty applies to the original purchaser with invoice or proof of purchase and covers Fire Magic products intended for personal, family, or household usage only. It does not apply to rust, corrosion, oxidation, or discoloration, which may occur due to moisture or overheating, unless the affected component becomes inoperable. This warranty does not cover parts becoming defective by misuse, accidental damage, improper handling, and/or installation. It does not cover labor or labor related charges. It specifically excludes liability for indirect, incidental or consequential damages. Some states do not allow the exclusion or limitation of incidental or consequential damages, so the above exclusion may not apply to you. This warranty gives you specified legal rights and you may have other rights, which may vary from state to state.

For additional information regarding this warranty, or information on how to place a warranty claim, contact your authorized Fire Magic dealer.

## ROBERT H. PETERSON CO.

Quality Check

Date: \_\_\_\_\_

Orifice # (Main): \_\_\_\_\_

Orifice # (Other): \_\_\_\_\_

Leak Test: \_\_\_\_\_

Burn Test: \_\_\_\_\_

Gas Type: NAT. / PROPANE

Model #: \_\_\_\_\_

Serial #: \_\_\_\_\_

Air Shutter: \_\_\_\_\_

Inspector: \_\_\_\_\_

Robert H. Peterson Co. • 14724 East Proctor Ave. • City of Industry, CA 91746