

Fire Magic®
The Ultimate Barbecue

**REGAL MAGNUM
SLIDE-IN OUTDOOR GAS
BARBECUE**

**INSTALLATION
INSTRUCTION AND
OWNER'S MANUAL**



INSTALLER: Leave these instructions with consumer.
CONSUMER: Retain for future reference.

IMPORTANT: READ THESE INSTRUCTIONS CAREFULLY BEFORE STARTING INSTALLATION OR USE

SAFETY WARNINGS & CODES

⚠ DANGER:

IF YOU SMELL GAS:

1. Shut off the gas to the appliance.
2. Extinguish any open flame.
3. Open lid.
4. If odor continues, keep away from the appliance and **immediately** call your gas supplier or fire department.

⚠ WARNING:

1. Do not store or use gasoline or other flammable vapors and liquids in the vicinity of this or any other appliance.
2. A propane cylinder not connected for use shall not be stored in the vicinity of this or any other appliance.

CODE AND SUPPLY REQUIREMENTS: This barbecue must be installed in accordance with local codes and ordinances, or, in the absence of local codes, with either the latest *National Fuel Gas Code (ANSI Z223.1/NFPA 54)*, or *Natural Gas and Propane Storage and Handling Installation Code (CSA-B149.1)* as applicable.

This appliance and its individual shutoff valves must be disconnected from the gas-supply piping system when testing the system at pressures in excess of ½ psig (3.5 kPa).

This appliance must be isolated from the gas-supply piping system by closing its individual manual shutoff valves during any pressure testing of the gas-supply system at pressures up to and including ½ psig (3.5 kPa).

⚠ WARNING:

Improper installation, adjustment, alteration, service, or maintenance can cause injury or property damage. For proper installation, refer to the installation instructions. For assistance or additional information, consult a qualified professional installer, service agency, or the gas supplier.

Certified to ANSI: Z21.58-2005

All electrical outlets in the vicinity of the barbecue must be properly grounded in accordance with local codes, or, in the absence of local codes, with the *National Electrical Code, ANSI/NFPA 70*, or the *Canadian Electrical Code, CSA C22.1*, whichever is applicable.

Keep all electrical-supply cords and fuel-supply hoses away from any heated surface.



Robert H. Peterson Co. • 14724 East Proctor Avenue • City of Industry, CA 91746

Fire Magic®

The Ultimate Barbecue

BARBECUE EXTÉRIEUR DE GAZ DU MAGNUM SLIDE-IN DE REGAL

INSTALLATION INSTRUCTIONS ET MANUEL DU PROPRIÉTAIRE

INSTALLATEUR : Laissez ces instructions avec le consommateur.
CONSOMMATEUR : Maintenez pour la future référence.



IMPORTANT: LISEZ CES INSTRUCTIONS SOIGNEUSEMENT AVANT DE COMMENCER L'INSTALLATION OU L'UTILISATION

SAFETY WARNINGS & CODES

⚠ DANGER:

SI VOUS SENTEZ LE GAZ :

1. Coupez le gaz à l'appareil.
2. Éteignez-vous n'importe quelle flamme nue.
3. Ouvrez le couvercle si équipé d'un four.
4. Si l'odeur continue, gardez loin de l'appareil et appelez immédiatement votre département de fournisseur ou de feu de gaz.

⚠ AVERTISSEMENT:

1. Ne stockez pas ou n'employez pas l'essence ou d'autres vapeurs et liquides inflammables à proximité de ceci ou d'aucun autre appareil.
2. Un cylindre de propane non relié pour l'usage ne sera pas stocké à proximité de ceci ou d'aucun autre appareil.

CONDITIONS DE CODE ET D'APPROVISIONNEMENT: Ce barbecue doit être installé selon des codes et des ordonnances locaux, ou, en l'absence des codes locaux, avec l'un ou l'autre le plus défunt *Code national de gaz de carburant* (norme ANSI Z223.1/NFPA 54), et *Stockage de gaz naturel et de propane et manipulation du code d'installation* (CSA-B149.1).

Cet appareil et ses différents robinets d'isolement doivent être démontés du gaz-fournissent le système sifflant en examinant le système aux pressions au-dessus du ½ psig (kPa 3.5).

Cet appareil doit être isolé dans gaz-fournissent le système sifflant par fermeture que ses différents robinets d'isolement manuels pendant tous les essais sous pression du gaz-fournissent le système aux pressions jusques et y compris le ½ psig (kPa 3.5).

⚠ AVERTISSEMENT:

L'installation inexacte, l'ajustement, le changement, le service, ou l'entretien peuvent causer des dommages ou des dégâts matériels. Référez-vous à ce manuel. Pour l'aide ou l'information additionnelle, consultez un installateur professionnel qualifié, l'agence de service, ou le fournisseur de gaz.

Certifié à la norme ANSI : Z21.58-2005

Toutes les sorties électriques à proximité du barbecue doivent être correctement fondues selon des codes locaux, ou en l'absence de local code, avec le code électrique national, ANSI/NFPA 70, ou le code électrique canadien, CSA C22.1, celui qui est applicable.

Maintenez tout électrique-fournissent des cordes et carburant-fournissent des tuyaux partis de n'importe quelle surface de chauffage.



Robert H. Peterson Co. • 14724 East Proctor Ave. • City of Industry, CA, USA 91746

CONTENTS

SAFETY WARNINGS & CODES	1
TOOLS REQUIRED	3
PARTS LIST	4
BACKBURNER PARTS LIST	5
ROTISSERIE PARTS LIST	5
WIRING DIAGRAM	6
MODEL SPECIFICATIONS TABLE	7
BARBECUE SAFETY INFORMATION & MAINTENANCE	7
PLANNING THE LOCATION OF THE BARBECUE	9
GAS-SUPPLY REQUIREMENTS	9
ELECTRICAL INSTALLATION	10
INSTALLING THE MAGNUM SLIDE-IN	11
SAFE USE & MAINTENANCE OF PROPANE-GAS CYLINDERS	13
BURNER AIR SHUTTER ADJUSTMENT	15
FIRE MAGIC® DRIP TRAY	17
SUPPLIED ITEMS	18
BARBECUE CONTROL FACE	18
LIGHTING (IGNITION) INSTRUCTIONS	19
MAGNUM BARBECUING TIPS	21
SETTING AND USING YOUR DIGITAL THERMOMETER	22
USING THE INFRARED BURNER (OPTION)	24
ROTISSERIE INSTRUCTIONS	25
ACCESSORIES	26
BARBECUE CARE & CLEANING	27
BARBECUE COVER	27
MAGNUM ELECTRICAL MAINTENANCE	28
TROUBLESHOOTING	29
CONVERTING THE GAS SUPPLY	30
CHECKING/CONVERTING THE BARBECUE REGULATOR	30
FIRE MAGIC® OUTDOOR GAS BARBECUES LIMITED WARRANTY	34

TOOLS REQUIRED

TOOLS AND SUPPLIES REQUIRED FOR INSTALLATION

- #2 (medium) Phillips screwdriver
- Two medium-size adjustable wrenches
- One pair of pliers
- One flat-blade screwdriver
- *3/8" wrench or 3/8" socket screwdriver
- Pipe joint compound resistant to all gasses

*Note: 3/8" socket and a 5/16" socket with a spacer (#6 nut) if gas orifice change is required.

ILLUMINATING THE GRILL AREA

Your Regal Magnum barbecue is equipped with a set of two (2) lights for illuminating the grill. Press and release the push button located on the far right of the barbecue face to toggle the lights on or off. The lights shut off automatically when the barbecue lid is closed and come back on again when it is re-opened.

PARTS LIST

Item No.	Part No.	Description
1.	3544-S-3 or 3527-5	Cooking grid, 22" x 10" s.s. rod (Set of 3) Porcelain cast iron 22" x 6" (Set of 5)
2.	3057-S	Flavor grid (3)
3.	3041-50 or 3050	Burners, ser. II s.s. cast (3) Infrared burner (optional)
4.	23739-51	Oven lid
5.	3199-62	Ignitor (4)
6.	3061-S	Zone separators (2)
7.	24193-21	Valve manifold
8.	3084	Drip tray
9.	24193-07	Face
10.	3062-S	Smoker drawer
11.	3673S-M	Warming rack
12.	3015	Knob, large (3)
13.	3016	Knob, small (2)
14.	24187-12	Digital thermometer module
15.	24187-13	Therm. wire, thermocouple, battery pack

To order replacement parts, contact your local Fire-Magic® dealer.

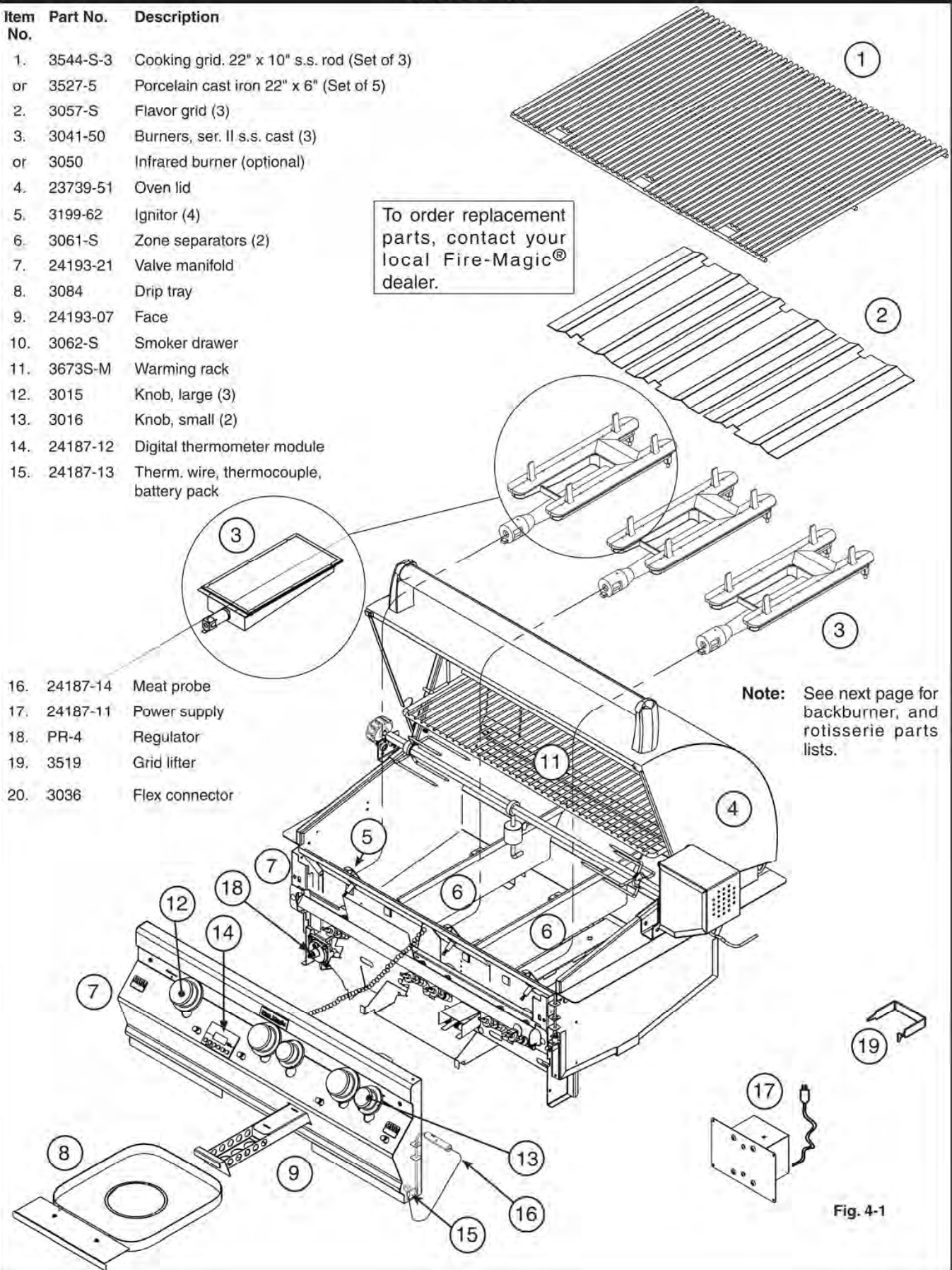

Fig. 4-1

BACKBURNER PARTS LIST

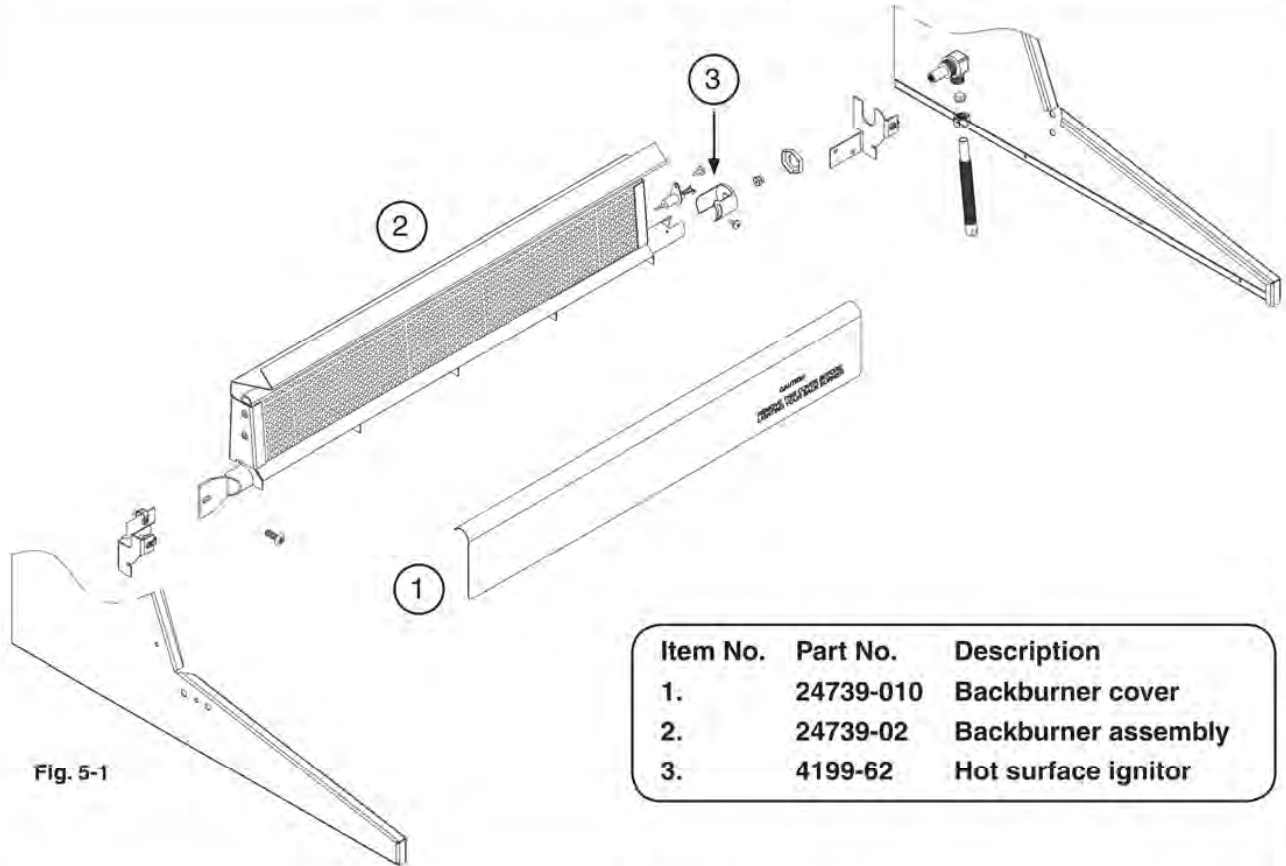
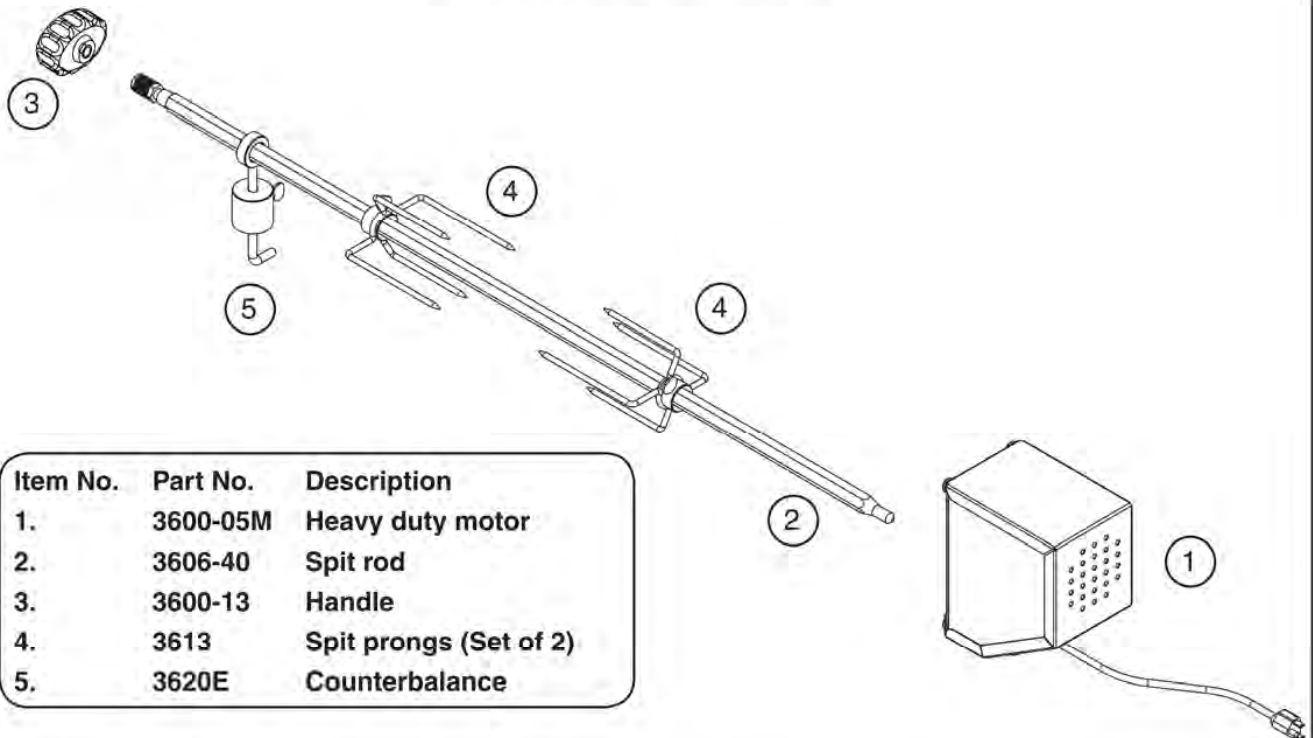

Fig. 5-1

Item No.	Part No.	Description
1.	24739-010	Backburner cover
2.	24739-02	Backburner assembly
3.	4199-62	Hot surface ignitor

ROTISSERIE PARTS LIST



Item No.	Part No.	Description
1.	3600-05M	Heavy duty motor
2.	3606-40	Spit rod
3.	3600-13	Handle
4.	3613	Spit prongs (Set of 2)
5.	3620E	Counterbalance

WIRING DIAGRAM

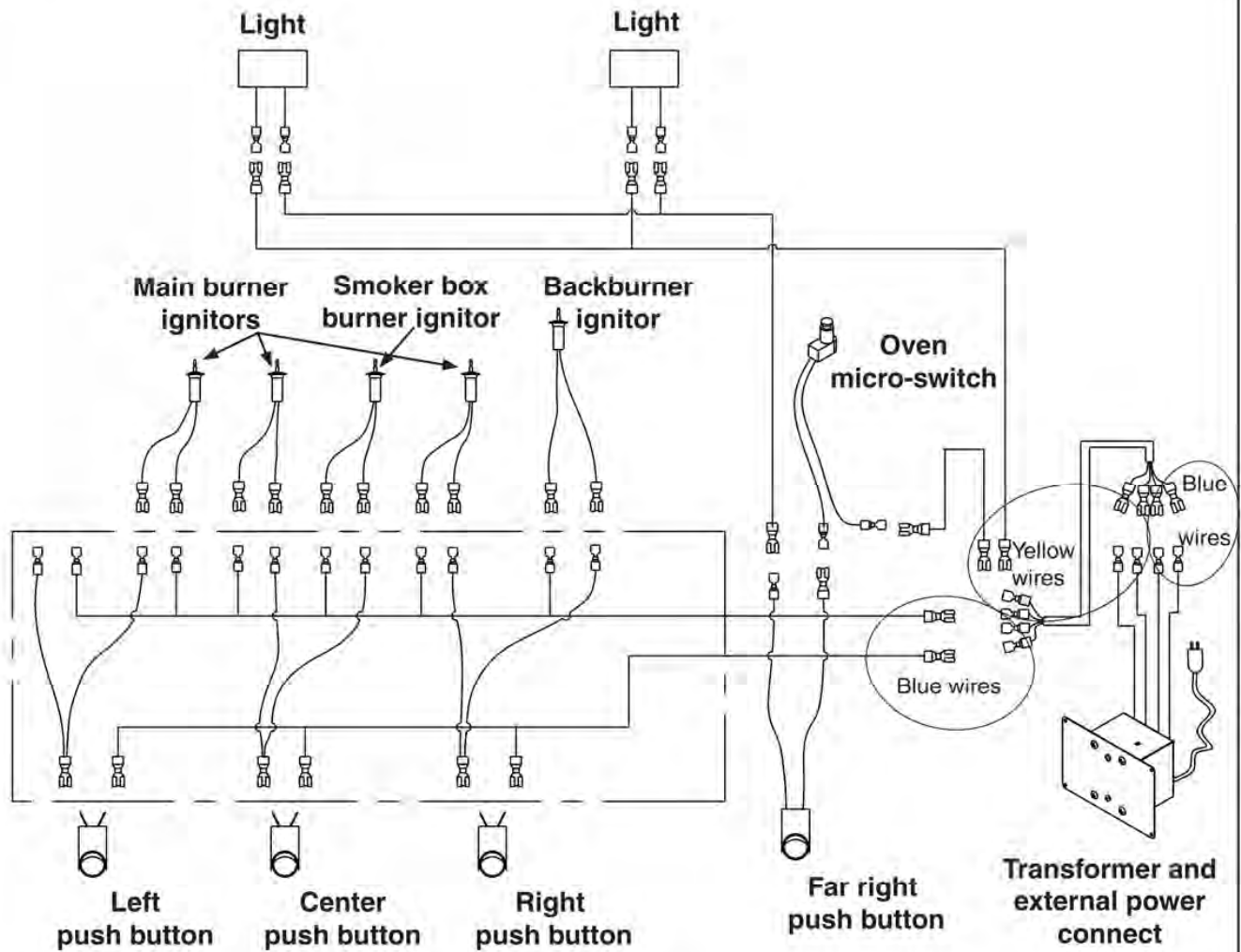

ELECTRICAL CONNECTIONS

This barbecue utilizes external electrical power for illumination and ignition control.

This means that in order to follow the electrical lighting instructions for your barbecue, it must first be connected to the electrical power grid. See **ELECTRICAL JUNCTION BOX HOOKUP** in **INSTALLATION** section.

OVEN LIGHT

To turn on the oven lights, open the oven, then push the button on the far right of the barbecue control face (see **SUPPLIED ITEMS** list) until it clicks.

The lights will automatically turn off when the oven door is closed and then turn on again when it is reopened (much like the light in your refrigerator).

Note: A convenient test that electrical power is available for lighting and other functions is to turn on the oven lights. If the lights do not come on, check your electrical connection.

MODEL SPECIFICATIONS TABLE

REGAL MAGNUM SPECIFICATIONS

	Natural	Propane
Main burner		
BTU per Burner	25,000	25,000
Gas Orifice Size	#42	#54
Backburner		
BTU per Burner	19,000	19,000
Gas Orifice Size	#47	#55
Wood chip burner		
BTU per Burner	2,500	2,500
Gas Orifice Size	#68	#77
Infrared burner		
BTU per Burner	24,000	24,000
Gas Orifice Size	#45	#55
Counter cut-out dimensions		
Counter Opening Height*	12"	
Counter Opening Width*	32-1/4"	
Counter Opening Depth*	23-3/4"	
Other specifications		
Weight	237 lbs.	

Table 1

***Note:** If using an insulating liner, consult liner instructions for counter cut-out dimensions.

BARBECUE SAFETY INFORMATION & MAINTENANCE

Each time you light this barbecue, make sure that:

1. The area around the barbecue is clear of flammable substances such as gasoline, yard debris, wood, etc.
2. There is no blockage of the airflow through the vent space located below the face of the unit.
3. When using propane gas:
 - a. **Keep the ventilation openings in the enclosure free and clear of debris.**
 - b. **Carefully inspect the rubber hose attached to the regulator before each use.**
 - c. **Install The propane cylinder, regulator, and rubber hose in a location not subject to heating above 125° F (51° C).**
4. The burner flames burn evenly along both sides of each burner with a steady flame (mostly blue with yellow tipping). See section on AIR SHUTTER ADJUSTMENT. If burner flames are not normal, check the orifice and burner for insects or insect nests.
5. The inline gas valve or gas cylinder valve is always shut OFF when the barbecue is not in use.
6. The drip collector hole is clear and unobstructed. Excessive grease deposits can result in a grease fire.
7. Do not operate the backburner with its cover installed.
8. Keep the barbecue free and clear from combustible materials, gasoline, and other flammable vapors and liquids.

WARNING: NEVER cover the *entire* cooking or grill surface with griddles or pans. Overheating will occur and burners will not perform properly when combustion heat is trapped below the cooking surface.

CAUTION: NEVER spray water on a hot gas unit.

▲ AVERTISSEMENTS

Avertissements généraux :

- Ce barbecue est pour utilisation à l'extérieur seulement. Si l'appareil est entreposé à l'intérieur, enlever les bouteilles et les laisser à l'extérieur.
- Ne pas ranger le gril immédiatement après l'avoir utilisé. Le laisser refroidir avant de le déplacer ou de le ranger. Le non respect de cette mesure de sécurité pourrait entraîner un incendie causant des dommages à la propriété, des blessures ou la mort.
- Ne pas utiliser cet appareil sous une surface combustible.
- Ne pas utiliser cet appareil sous un auvent. Le non respect de cette mesure de sécurité pourrait entraîner un incendie ou des blessures.
- Dégagement minimal entre les parois latérales et l'arrière de l'appareil et la construction combustible (45.7 cm à partir des parois latérales et 45.7cm à partir de l'arrière).
- Le régulateur de pression de gaz prévu avec cet appareil de cuisson à gaz pour l'extérieur doit être utilisé. Ce régulateur est réglé pour une pression de sortie de 5 pouces de colonne de l'eau pour le gaz naturel, et 10 pouces pour le propane.
- LE RÉGULATEUR INCLUS D'APPAREILS EST ÉVALUÉ POUR LE MAXIMUM DE 1/2 (LIVRES PAR POUCE CARRÉ). SI VOTRE OFFRE DE GAZ EST 1/2 PLUS GRAND QUE (LIVRES PAR POUCE CARRÉ), UN RÉGULATEUR ADDITIONNEL DOIT ÊTRE INSTALLÉ AVANT LE BARBECUE. VOIR LA SECTION DE CONDITIONS D'OFFRE DE GAZ POUR LA PRESSION APPROPRIÉE D'OFFRE DE GAZ.
- Ne couvrez jamais la surface entière de cuisine ou de gril de gauffreuses ou de casseroles. La surchauffe se produira et les brûleurs ne seront pas très performants quand la chaleur de combustion est emprisonnée au-dessous de la surface à cuire.
- Ne pulvérisez jamais l'eau sur une unité chaude de gaz, comme ceci peut endommager des composants de porcelaine ou de fer de fonte.

Avertissements de propane :

- Une fuite de GPL peut causer un incendie ou une explosion si enflammée entraînant des blessures corporelles graves ou la mort.
- Communiquez avec le fournisseur de GPL pour les réparations ou pour disposer de qules bouteille ou du GPL non utilisé.

PLANNING THE LOCATION OF THE BARBECUE

This barbecue is designed for outdoor use only. **DO NOT use this unit under unprotected flammable surfaces. DO NOT use this appliance inside a building, garage, or any other unprotected covered area (see EXHAUST REMOVAL below). DO NOT use this barbecue in or on a recreational vehicle or boat.**

IMPORTANT: When installing this barbecue in a combustible surround, an R. H. Peterson insulating liner must be used. The unit must have a minimum of 18" (45.7 cm) of clearance to the right, left, and back from unprotected combustible materials such as wood, plastic, or stucco with wood framing.

The face of the unit is removable for servicing and air shutter adjustment (see PARTS LIST).

Note: Keep electrical-supply cords away from all heated surfaces.

ENSURING PROPER COMBUSTION AIR AND COOLING AIRFLOW

You must maintain proper airflow for the barbecue to perform as it was designed (Fig. 9-1). If airflow is blocked, overheating and poor combustion will result. Do not block the 1" (2.5 cm) front air inlet along the bottom of the face or more than 75% of the cooking grid surface with pans or griddles.

Note: The 1" (2.5 cm) front air space allows access to the drip tray.

ELECTRICAL OUTLETS

All electrical outlets in the vicinity of the barbecue must be properly grounded.

EXHAUST REMOVAL

If installed or used under a patio roof, the cooking grid area must be fully covered by a chimney and exhaust hood. An exhaust fan with a rating of 1,000 CFM (cubic feet per minute) (472 liters per second) or more may be necessary to effectively remove smoke and other cooking by-products from the covered area. This barbecue shall not be used under overhead combustible construction. **THIS UNIT SHOULD NOT BE LOCATED IN A FULLY ENCLOSED AREA OF ANY KIND.**

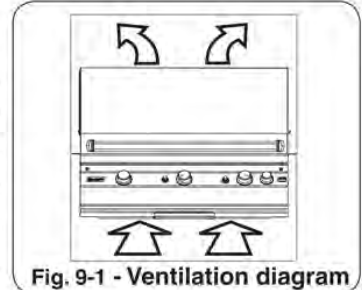

Fig. 9-1 - Ventilation diagram

GAS-SUPPLY REQUIREMENTS

GAS-SUPPLY PLUMBING REQUIREMENTS

For natural gas or a household propane system, rigid $1/2$ " (1.3 cm) or $3/4$ " (1.9 cm) black steel pipe or local code-approved pipe is required to conduct the gas supply to the unit. An outdoor-approved flexible connector can be used to connect the household gas supply to the barbecue. **DO NOT use a rubber hose within the barbecue enclosure.** Apply only joint compounds that are resistant to all gasses on all male pipe fittings. Make sure to tighten every joint securely.

Note: If $1/2$ " (1.3 cm) pipe is used with **natural gas**, it should be no longer than 20' (6.1 meters).

Important: An external valve (with a removable key) in the gas line is necessary for safety when the barbecue is not in use. It also provides for convenient maintenance.

ELECTRICAL INSTALLATION

POWER SUPPLY HOOKUP

CAUTION: IMPROPERLY CONNECTED WIRES WILL CAUSE DAMAGE TO THE BARBECUE AND MAY RESULT IN PROPERTY DAMAGE AND/OR PERSONAL INJURY.

This barbecue includes a power supply. When installed, the power supply must be located at least 12 inches below the barbecue.

Fasten the power supply box to the inside of the enclosure, making sure the vent holes have access to circulating air.

If you purchased the Power Hood option, this box must be accessible from outside the enclosure to synchronize the transmitter and receiver.

The electrical connections from the power supply to the barbecue electrical systems come pre-connected using a four-wire insulated bundle with two sets of color-coded leads. If it becomes necessary to disconnect any of these electrical connections to install the barbecue, they must be reconnected exactly as they were originally.

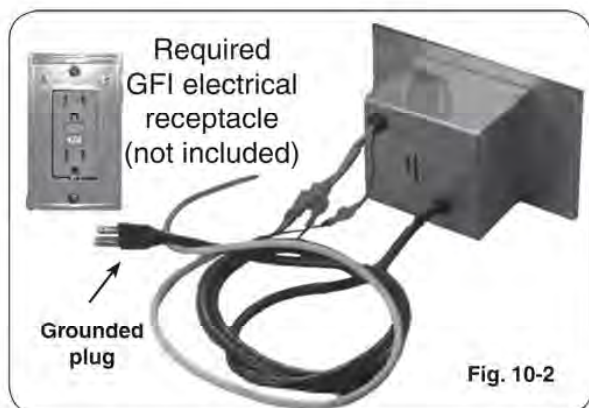
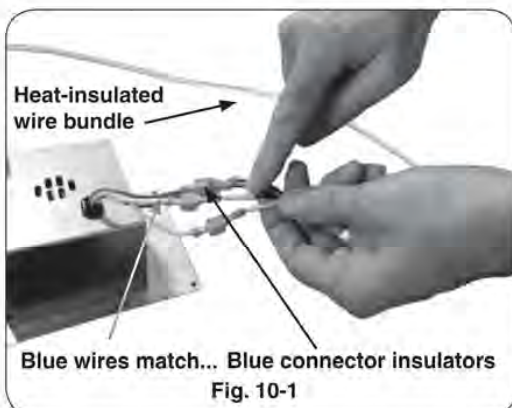

WARNING

Electrical Grounding Instructions

This outdoor-cooking gas appliance is equipped with a three-pronged (grounding) plug for your protection against shock hazard and should be plugged directly into a properly grounded three-prong receptacle. Do not cut or remove the grounding prong from the plug.

CONNECTING THE POWER SUPPLY TO LINE POWER

1. Locate the power cord coming out of the power supply with the standard three-pronged grounded plug at the end (see Fig. 10-2).
2. Plug the end of the cord into a properly wired and inspected GFI electrical receptacle using a heavy-duty grounded extension cord if necessary. Alternately, a qualified professional electrician may cut the plug off the cord and wire it into line power if desired.

INSTALLING THE MAGNUM SLIDE-IN

COUNTER PREPARATION

Consult Table 1 and Fig. 12-1 for noncombustible construction counter cut-out dimensions. A Robert H. Peterson insulating liner must be used if the counter or any supporting construction is combustible. Consult the instructions that come with the liner for dimensions and additional installation information before beginning the installation.

This outdoor slide-in barbecue is designed to be supported by the stainless-steel hangers extending from the upper portion of the barbecue as they rest on the left, right, and back of the countertop and by the two front structural supports located under the barbecue on the left and right sides (see Fig. 11-2).

The hanger in the back of the barbecue is sufficient to support the rear weight of the barbecue, but because the face rules out a similar hanger in front, additional supports are required to hold up the forward weight of the barbecue.

These supports will require noncombustible shims (brick, concrete, metal, etc.) to be inserted between them and the bottom of the barbecue cut-out structure as shown in Fig. 11-3. The exact height of the shims will depend on the exact height of the barbecue cut-out in relation to the countertop.

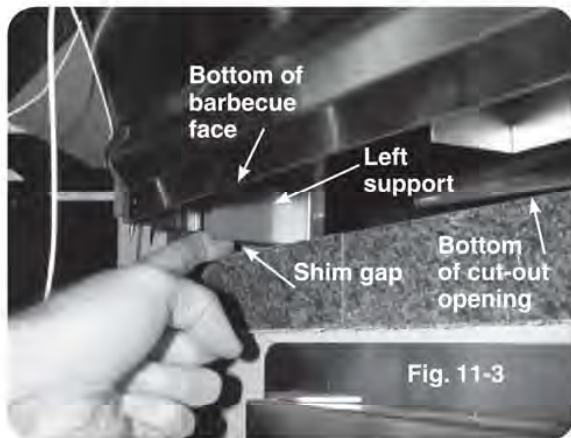

Important: The shims must not be so tall that they raise the front of the left-side or right-side hangers off the countertop.

The face of the barbecue rises from the base of the barbecue up to counter level. It is designed to extend in its entirety from the front of the counter (see Fig. 11-2). If the countertop extends beyond

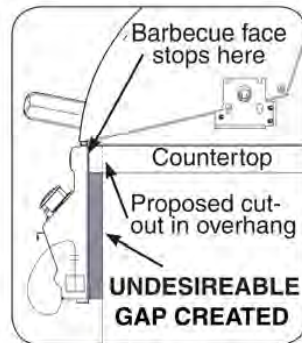

Fig. 11-1

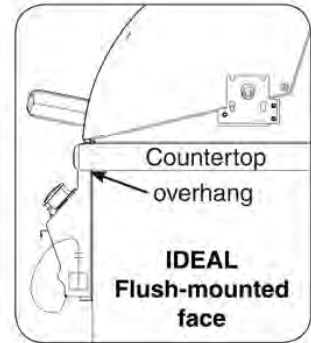

Fig. 11-2

the counter face, creating a countertop overhang (see Fig. 11-1), it must be cut flush with the counter face where the barbecue will be installed, or a gap will be created, exposing the forward portions of the left- and right-side firewalls.

CONNECTING THE GAS SUPPLY

- Use the attached C.S.A.-approved stainless-steel flex connector to connect to the gas supply. An NPT adapter has been provided for 1/2" pipe. Bring the gas supply from the gas line stub to the valve manifold.

CAUTION: Use only C.S.A.-listed stainless-steel flex connectors within the enclosure.

WARNING

A rubber or plastic connector will rupture or leak, resulting in an explosion or serious injury if used inside the barbecue enclosure.

- The flex connector is routed under the left-side support wall of the frame. Run it from the bottom, left, and rear of the unit to the stub.
- Turn OFF the gas supply at the source.** Then connect the 1/2" pipe adapter fitting supplied with the stainless-steel flex connector to the gas-supply stub. Use pipe joint compound that is resistant to all gasses on the male pipe fitting and tighten securely. **DO NOT use pipe joint compound to connect flare fittings.**
- Hook up the electrical power supply per the instructions on the preceding page.**
- Slide your barbecue into place, making sure not to pinch or kink the gas connector line.

INSTALLING THE MAGNUM SLIDE-IN (Cont.)

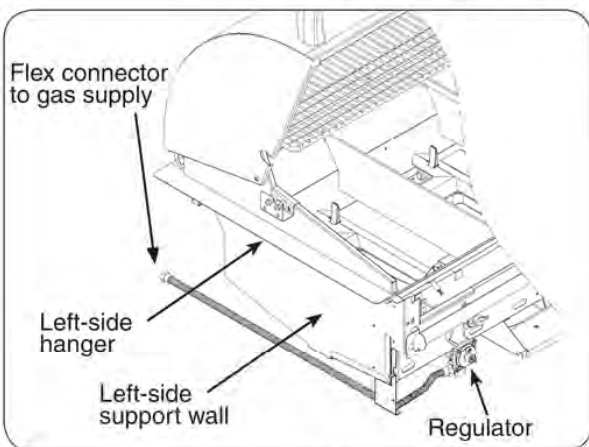

Fig. 12-1

- f. Turn all barbecue burner valves to the **OFF** position. Turn the gas supply on. Then carefully check *all* gas connections for leaks with a brush and soapy water before lighting. **NEVER USE A MATCH OR OPEN FLAME TO TEST FOR LEAKS.**
- g. Refer to the **AIR SHUTTER ADJUSTMENT** instructions and **LIGHTING INSTRUCTIONS** of this manual before replacing the barbecue face and knobs.

SAFE USE & MAINTENANCE OF PROPANE-GAS CYLINDERS

IMPORTANT FOR YOUR SAFETY

READ AND FOLLOW ALL WARNINGS PROVIDED WITH THE PROPANE-GAS CYLINDER.

When operating this appliance with a propane-gas cylinder, these instructions and warnings **MUST** be observed.

FAILURE TO DO SO MAY RESULT IN A SERIOUS FIRE OR EXPLOSION.

CYLINDER/CONNECTOR REQUIREMENTS

- Propane-gas cylinders, valves, and hoses must be maintained in good condition and must be replaced if there is visible damage to either the cylinder or valve. If the hose is cut or shows excessive abrasion or wear, it must be replaced before using the gas appliance (see e.).
- This barbecue, when used with a cylinder, should be connected to a standard 5-gallon (20 lb.) propane-gas cylinder equipped with an OPD (Overfill Prevention Device). The OPD has been required on all cylinders sold since October 1, 1998, to prevent overfilling.
- Cylinder dimensions should be approximately 12" (30.5 cm) in diameter and 18" (45.7 cm) high. Cylinders must be constructed and marked in accordance with the *Specifications for Propane Gas Cylinders of the U.S. Department of Transportation (D.O.T.)* or the National Standard of Canada, *CAN/CSA-B339, Cylinders, Spheres, and Tubes for Transportation of Dangerous Goods*.
- The cylinder must include a collar to protect the cylinder valve, and the cylinder supply system must be arranged for vapor withdrawal.
- The pressure regulator and hose assembly used must match the specification for Type I by *ANSI Z 21.58-2005/CGA 1.6-2005* (see Fig. 13-1). This unit is not equipped with a propane regulator but if it is set up for use with propane gas, then the regulator must meet the above specification. Contact your local dealer for more information.
- The propane-gas cylinder valve must be equipped with a cylinder connection coupling device, described as Type I in the standard defined in paragraph e. above. This device is commonly described as an Acme thread quick coupler.
- If the propane-gas cylinder comes with a dust plug, place the dust cap on the cylinder valve outlet whenever the cylinder is not in use.

QUICK COUPLER OPERATION

To connect the regulator/hose assembly to the propane-gas cylinder valve fitting: Press the hand nut on the regulator over the Acme thread fitting on the cylinder valve. Turn the hand nut clockwise to engage the threads and tighten until snug.

PROPANE CYLINDER ENCLOSURES

FOR YOUR SAFETY, you must provide the openings listed below for drainage, replacement air, and cross-ventilation of any storage area exposed to possible leakage from gas connections, the barbecue, or propane cylinders:

One side of the gas cylinder enclosure left completely open to the outside **OR** by providing four (4) ventilation openings. Two (2) openings are to be at the cylinder valve level (approx. 16" [40.6 cm] above the floor) and on opposite walls of the enclosure. Two (2) more openings must be at the floor level on opposite sides of the enclosure. The floor-level openings must start at the floor and shall extend no higher than 5" (12.7 cm) above the floor. Each opening must have a minimum of 10 sq. in. (64.5 cm²) of free area. To achieve the proper ventilation, you may drill a series of holes, omit the grout from masonry joints, or replace a brick with a hardware cloth screen. If the floor in the cabinet is raised and the space beneath the cabinet is open to the outside, the lower ventilation openings may be in the floor.

Consult your gas supplier for ventilation and regulator requirements when connecting to a household propane supply.

The use of pliers or a wrench should not be necessary. Only cylinders marked "propane" may be used.

To disconnect: Turn the hand nut counterclockwise until detached (Fig. 13-1).

Important: Before using the barbecue, and after each time the cylinder is removed and reattached, check the hose for wear (see a.) and check all connections for leaks. Turn off the barbecue valves and open the main cylinder valve, then check connections with soapy water. Repair any leaks before lighting the barbecue.

CAUTION: Always turn the propane cylinder main valve off after each use, and before moving the barbecue and cylinder or disconnecting the coupling. This valve must remain closed and the cylinder disconnected while the appliance is not in use, even though the gas flow is stopped by a safety feature when the coupler is disconnected.

Carefully inspect the hose assembly each time before the gas is turned on. A cracked or frayed hose should be replaced immediately.

If the appliance is stored indoors, the cylinder must be disconnected and removed. **Cylinders must be stored out of doors, out of the reach of children**, and must not be stored in a building, garage, or any other enclosed area.

FOR YOUR SAFETY

- DO NOT store a spare propane-gas cylinder under or near this appliance.
- NEVER fill the cylinder beyond 80-percent full.
- IF THE INFORMATION IN a. AND b. IS NOT FOLLOWED EXACTLY, A FIRE CAUSING DEATH OR SERIOUS INJURY MAY OCCUR.

Fig. 13-1 Type I Acme thread quick coupler

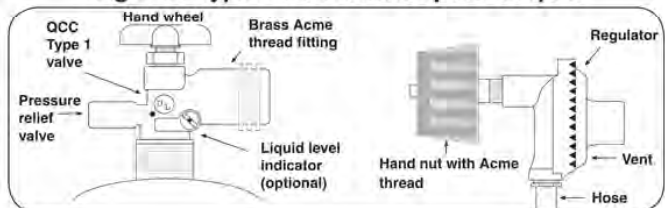

UTILISATION SÛRE ET ENTRETIEN DES CYLINDRES DE GAZ DE PROPANE

IMPORTANT POUR VOTRE SÛRETÉ

LISEZ ET SUIVEZ TOUS LES AVERTISSEMENTS ÉQUIPÉS DE VOTRE CYLINDRE DE GAZ DE PROPANE.

En actionnant cet appareil avec un cylindre de gaz de propane ON DOIT observer ces instructions et avertissements.

LE MANQUE DE FAIRE AINSI PEUT AVOIR COMME CONSÉQUENCE UNE INCENDIE OU UNE EXPLOSION SÉRIEUSE.

CYLINDRE ET CONDITIONS ET

CARACTÉRISTIQUES DE CONNECTEUR

- Des cylindres et les valves de gaz de propane doivent être maintenus en bon état et doivent être remplacés s'il y a des dommages évidents au cylindre ou à la valve.
- Ce barbecue, une fois utilisé avec un cylindre, devrait être relié à un gallon de la norme 5 (20lb.) cylindre de gaz de propane équipé d'un OPD (remplissez au-dessus du niveau le dispositif d'empêchement). L'OPD a été exigé sur tous les cylindres vendus depuis octobre 1.1998 pour empêcher le remplissage excessif.
- Les dimensions de cylindre devraient être approximativement 12" (30.5cm) de diamètre et 18" (45.7cm) hauts. Des cylindres doivent être construits et marqués selon les caractéristiques pour des cylindres de gaz de propane du département des ETATS-UNIS du transport (D.O.T.) ou le niveau national du Canada, du CAN/CSA-B339, des cylindres, des sphères et des tubes pour le transport des marchandises dangereuses.
- Le cylindre doit inclure un collier pour protéger la valve de cylindre et le circuit d'alimentation de cylindre doit être assuré le retrait de vapeur.
- Le régulateur de pression et l'ensemble de tuyau (fig. 14-1) fourni avec cet appareil à cuire extérieure de gaz doivent être utilisés. Les régulateurs d'original et de pression de remplacement et les ensembles de tuyau doivent être ceux indiqués par le Robert H. Peterson Cie. pour le raccordement avec un dispositif se reliant de cylindre identifié comme type I par la norme ANSI Z 21.58 et CGA 1.6-M95-1995 avec la norme ANSI Z 21.58a -1998 d'addenda et CGA 1.6a - M98.
- La valve de cylindre de gaz de propane doit être équipée d'un dispositif d'accouplement de raccordement de cylindre, décrit comme type I dans la norme définie dans le e. de paragraphe ci-dessus. Ce dispositif est généralement décrit comme coupleur rapide de fil de point culminant.
- Si votre cylindre de gaz de propane vient avec une prise de la poussière, placez le bouchon anti-poussière sur la sortie de valve de cylindre toutes les fois que le cylindre n'est pas en service.

OPÉRATION DE COUPLEUR RAPIDE

Pour relier le régulateur/hose à l'ajustage de précision de valve de cylindre de gaz de propane: Serrez l'écrou de main sur le régulateur au-dessus de l'ajustage de précision de fil de point culminant sur la valve de cylindre. Tournez l'écrou de

main dans le sens des aiguilles d'une montre pour engager les fils et pour serrer jusqu'à ce que douillettement. L'utilisation des pinces ou de la clé ne devrait pas être nécessaire. Seulement le propane marqué par cylindres doit être employé.

Pour débrancher: Tournez l'écrou de main dans le sens contraire des aiguilles d'une montre jusqu'à isolé (fig. 14-1).

Important: Avant d'employer le barbecue, et ensuite chaque fois que le cylindre est enlevé et rattaché, examinez tous les raccordements pour déceler les fuites. Arrêtez les valves de barbecue et ouvrez la valve principale de cylindre, puis vérifiez les raccordements avec de l'eau savonneuse. Réparez toutes les fuites avant d'allumer le barbecue.

ATTENTION: Tournez toujours la valve principale de cylindre de propane au loin après chaque utilisation, et avant de déplacer le barbecue et le cylindre, ou débrancher l'accouplement. Cette valve doit rester fermée et le cylindre a débranché alors que l'appareil n'est pas en service, quoique l'écoulement de gaz soit arrêté par un dispositif de sûreté quand le coupleur est débranché.

Inspectez soigneusement l'ensemble de tuyau chaque fois avant que le gaz soit allumé. Un tuyau criqué ou frangé devrait être remplacé immédiatement.

Si l'appareil est stocké à l'intérieur, le cylindre doit être débranché et enlevé. Des cylindres doivent être stockés hors des portes, hors de l'extension des enfants, et ne doivent pas être stockés dans un bâtiment, le garage, ou n'importe quel autre secteur inclus.

POUR VOTRE SÛRETÉ

- Ne stockez pas un cylindre de gaz disponible de propane dessous ou ne vous approchez pas de cet appareil.
- Ne remplissez jamais cylindre au delà de 80 pour cent de plein.
- SI L'INFORMATION DANS "A" ET "B" N'EST PAS SUIVIE EXACTEMENT, UN FEU CAUSANT LA MORT OU DES DOMMAGES SÉRIEUX PEUT SE PRODUIRE.

Fig. 14-1 type coupleur rapide de fil de point culminant d'I

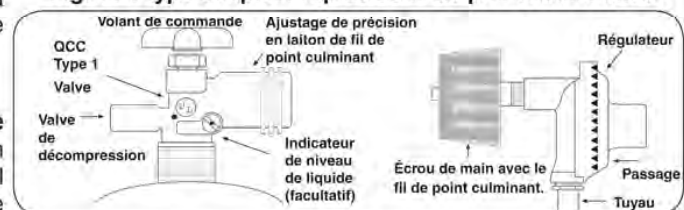

CLÔTURES DE CYLINDRE DE PROPANE

POUR VOTRE SÛRETÉ, vous devez fournir les ouvertures suivantes ci-dessous pour le drainage, l'air de rechange, et la ventilation en travers de n'importe quelle zone de stockage exposée à la fuite possible des raccordements de gaz, du barbecue, ou du cylindre de propane:

Un côté de la clôture de cylindre de gaz a laissé complètement ouvert de extérieur OU en fournissant quatre (4) ouvertures de ventilation. Deux ouvertures doivent être au niveau de valve de cylindre (approximativement 16" (40.6 centimètres) au-dessus du plancher) et sur les murs opposés de la clôture. Deux ouvertures supplémentaires doivent être au niveau de plancher des côtés opposés de la clôture. Les ouvertures de niveau de plancher doivent commencer au plancher et se prolongeront pas plus haut que 5" (12.7 centimètre) au-dessus du plancher. Chaque ouverture doit avoir un minimum de 10 pouces carrés (64.5 cm²) du secteur libre. Pour réaliser la ventilation appropriée, vous pouvez forer une série de trous, omettez le coulis des joints de maçonnerie, ou remplacez une brique avec un écran de tissu de matériel. Si le plancher dans le coffret est augmenté et l'espace sous le coffret est ouvert d'extérieur, les ouvertures inférieures de ventilation peuvent être dans le plancher.

BURNER AIR SHUTTER ADJUSTMENT

AIR SHUTTER ADJUSTMENT

Important: Air shutters are preset at the factory based on the gas the barbecue was built to burn. However, altitude or other local conditions may require air shutter adjustment for proper combustion.

MAIN BURNER

Flames from a properly adjusted main burner with no wind or breeze present will appear fairly steady, consistent, and almost entirely blue. The extreme tips of the flames may be light yellow. If the tip of a flame were to turn orange, it should only do so briefly and then become blue or light yellow again. The flames will appear to burn while touching the burner ports (see Fig. 15-1).

If the flames have orange in them and appear to undulate slowly from side to side, or if some of them appear to lift off the burner instead of touching it, then adjust the air shutter, as instructed below.

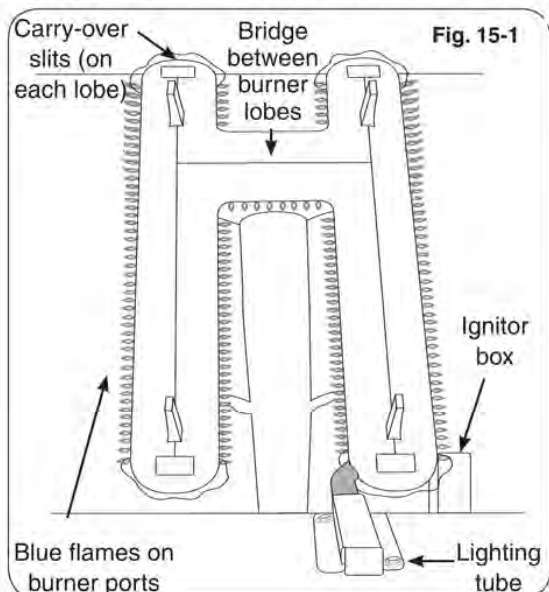

Fig. 15-1

CAUTION: Turn all burner control knobs to the **OFF** position and turn off the gas supply at the source before removing or adjusting a burner.

WARNING

Wait for the burner to be cool or use heavily insulated heat-resistant gloves when handling the burner.

1. Follow the safety precautions and steps for main burner removal in the **CHANGING THE MAIN BURNER ORIFICES** section (steps 1-5).

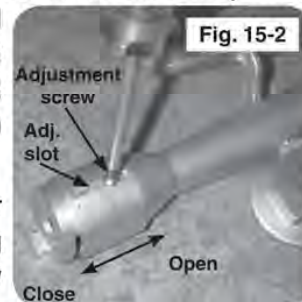

Fig. 15-2

2. Adjust the air shutter opening by loosening the adjustment screw with a screwdriver, then sliding the air shutter backward or forward to open or close the air shutter opening (see Fig. 15-2).

Shutter Setting	Flame Condition
Open too far	Flames shorten and lift off the burner
Ideal setting	Blue flames just touching burner (may have light-yellow tips)
Closed too far	"Lazy" flames with orange in them

Too large an air shutter opening will allow too much air into the burner, which will cause the flames first to shorten and then to appear to lift up off the ports. For the bottom of the flames to move closer to the ports, close the air shutter more.

If the air shutter opening is too small or closed, the flames will present consistently orange tips and become "lazy," slowly undulating back and forth.

For propane gas, ideal settings tend to be just slightly open. For natural gas, which generally requires less primary air than propane, the main burner air shutter may be nearly closed.

3. Adjust the air shutter opening and then replace the burner (steps 7-8 in the **CHANGING THE BACKBURNER ORIFICES** section).
4. Follow the lighting instructions in this manual to light the burner.
5. Repeat steps 1-4 until the flames appear to touch the burner ports, burning fairly steadily and almost entirely blue with occasional light-yellow tips (see Fig. 15-1).

BURNER AIR SHUTTER ADJUSTMENT (Cont.)

BACKBURNER

Flames from a properly adjusted backburner will appear as a horizontal line of even blue flames along the bottom of and behind the backburner grating. The grating itself will glow red after it heats up.

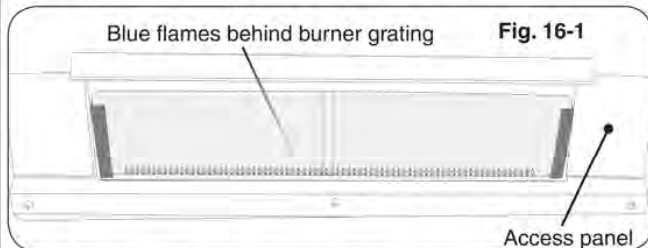

IMPORTANT: It is normal for the backburner to smoke when it is burned for the first time. Burning the backburner on **HI LIGHT** for approximately 15 minutes will eliminate the smoking.

If, instead of being blue and even, the backburner flames appear to have orange in them and waver slowly left and right, or if the flames appear to lift off the burner, adjust the backburner air shutter by following the steps below.

The backburner air shutter adjustment is located behind the right side of the access panel in the back of the oven, above the cooking grid.

Note: It is only necessary to remove the backburner access plate, not the backburner, when adjusting the backburner air shutter.

1. Follow the safety precautions and steps for backburner access panel removal (steps 1-6) in the CHANGING THE BACKBURNER ORIFICES section.

CAUTION: The backburner air shutter can be safely adjusted with the backburner lit if it is adjusted using a long-handled screwdriver or well-insulated fire- and heat-resistant gloves.

2. Adjust the air shutter opening by loosening the adjustment screw with a screwdriver, then sliding the air shutter backward or forward to open or close the air shutter opening (see Fig.16-2). Watch the backburner flames while adjusting the air shutter.



Too large an air shutter opening will allow too much air into the burner, which will cause the flames first to shorten and then to appear to lift up off the ports. For the bottom of the flames to move closer to the ports, close the air shutter more.

If the air shutter opening is too small or closed, the flames will present consistently orange tips and become "lazy," slowly wavering left and right.

3. Continue adjustment until the flames appear to touch the burner ports, burning fairly steady, consistently, and almost entirely blue with some light-yellow tips (see Fig. 16-1), then retighten the backburner air shutter adjustment screw.
4. Replace the backburner access plate (step 8 in the CHANGING THE BACKBURNER ORIFICES section).

FIRE MAGIC® DRIP TRAY



Pull out the drip tray



Fig. 17-3

Position match holder out of the way (if present)



Fig. 17-4

Place the drip tray liner



Fig. 17-5

Carefully slide the tray with liner back into the barbecue

Drippings from barbecuing flow through specially designed channels and collect in the drip tray. Check the drip tray regularly and empty when it nears full.

Fig. 17-1



Your barbecue includes a pack of four (4) Fire Magic® drip tray liners (Fig. 17-1). For your convenience in cleanup, place a liner into the drip tray before barbecuing.

To fit a liner into the drip tray, pull out the tray (Fig. 17-2) and set it on a flat, level surface (Fig. 17-3). Place the liner in the drip tray as shown in Fig. 17-4 and carefully insert the tray back into the barbecue face (Fig. 17-5).

After each use, wait for the barbecue to cool and carefully pull out the drip tray to check it. When a liner is nearing full, carefully lift it out of the drip tray, lifting with both hands to keep the tray level until it is safely discarded. Then insert a new drip tray liner.

Order more drip tray liners through your local Fire Magic® dealer.

Note: For barbecue models with match holders attached inside the drip tray, place the match holder off to one edge of the pan (Fig. 17-3). If necessary, mold the foil liner around them and the other features of the tray to create enough clearance space to open and close the tray without catching the liner.

Note: The foil tray liner is also useful for setting on burners to cover them and catch drippings directly during rotisserie cooking.

SUPPLIED ITEMS

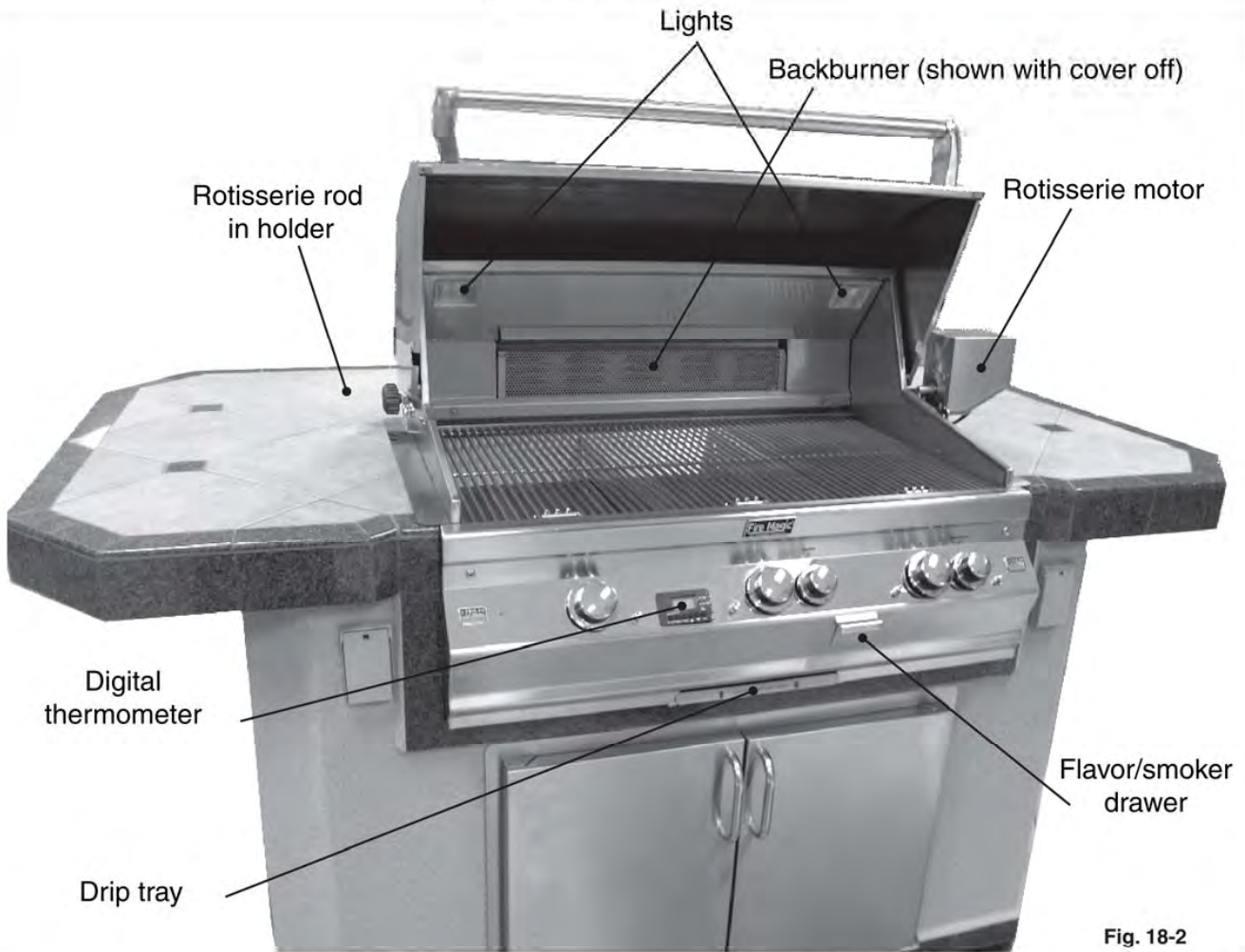

Fig. 18-2

Regal Magnum slide-in shown here in counter (not included)

ILLUMINATING THE GRILL AREA

Your Regal Magnum barbecue is equipped with a pair of lights for illuminating the grill. Press and release the push button located on the far right of the barbecue face to toggle the lights on or off. The lights shut off automatically when the barbecue lid is closed and come back on again when it is re-opened.

BARBECUE CONTROL FACE

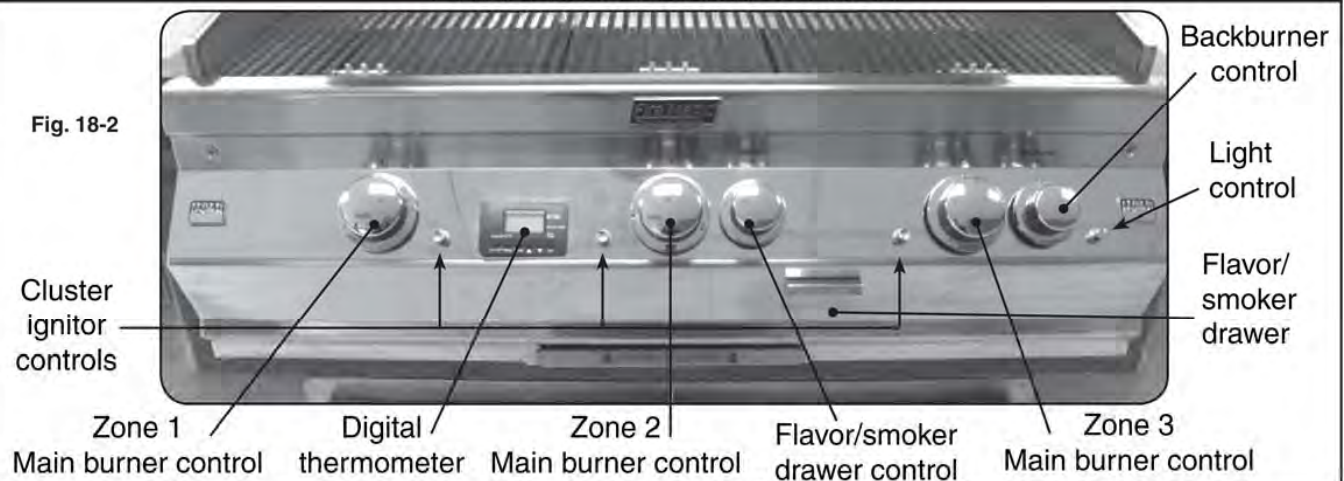

Fig. 18-2

LIGHTING (IGNITION) INSTRUCTIONS

Read all instructions before lighting, and follow these instructions each time you light the barbecue.

ELECTRONIC LIGHTING

1. Open lids or remove covers from burners to be lit.
2. Turn all gas control knobs to their **OFF** positions.
3. Turn on the gas at its source.

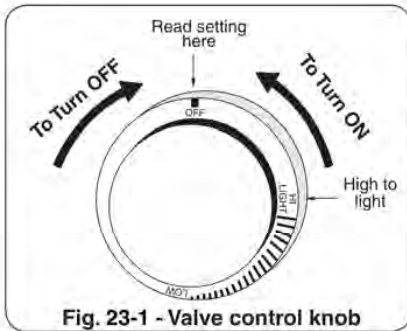

Note: DO NOT turn on more than one valve at a time for either electronic or manual lighting.

4. Press and hold the ignitor button nearest the control knob for the burner to be lit. Continue to hold in the ignitor button for five (5) seconds. The tip of the ignitor will glow orange. Keep holding the ignitor button while depressing the control knob and turning the knob to the **HI LIGHT** position. Once the burner lights, release the ignitor button.

CAUTION: If the burners do not light within five (5) seconds of pressing the ignitor button, depress the knob and turn it to the **OFF** position. **WAIT FIVE (5) MINUTES** before repeating step 4. If you smell gas, follow the instructions on the cover of this manual. If the burners still do not light after several attempts, refer to the instructions for manual lighting.

5. Repeat step 4 for each additional burner to be lit.

Important: When lighting the burner under the flavor/smoker drawer, first remove the drawer so that the burner can be easily seen. Then replace the drawer after the burner is lit.

WHEN USING A PORTABLE PROPANE TANK

Propane tanks are equipped with a safety shutdown device that may cause low or no gas pressure/flame at the burners if operating and lighting instructions are not followed exactly (see important note in the TROUBLESHOOTING section for more details.)

ADJUSTING THE FLAME

The large and small knobs on the face of the barbecue control the valves and adjust flame height. The first labelled position is **OFF**, the second **HI LIGHT**, and the third **LOW**. In between the **HI LIGHT** and **LOW** labels are midpoint marks. Flame height can be set anywhere between the **HI LIGHT** and **LOW** settings for all cooking requirements and methods.

Height of the flame **with a valve in LOW position** may be further regulated by means of a small adjusting screw in the center of the valve stem. This screw is accessible by removing the valve knob, which pulls straight off the end of the valve stem.

MANUAL LIGHTING

CAUTION: Always wait five (5) minutes for gas to clear after any unsuccessful lighting attempt.

1. Follow steps 1 through 3 (left).
2. Insert either a burning long-barrel butane lighter or a burning long-stem match through the cooking grid opening to the top of the lighting tube (Fig. 23-2). For backburners, hold the flame against the perforated material of the backburner.
3. While holding the match or lighter flame next to the burner or the top of the lighting tube, depress the appropriate valve knob and turn it counterclockwise to the **HI LIGHT** position. The burner will light.
4. If the burner does not light, **immediately depress the knob and turn the valve to OFF**. **WAIT FIVE (5) MINUTES** before repeating steps 2 through 4 of the **MANUAL LIGHTING** instructions.

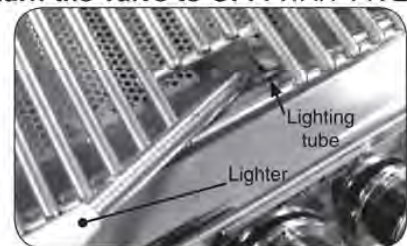

REMEMBER: FOR SAFE MANUAL LIGHTING, PLACE A BURNING MATCH OR BUTANE LIGHTER BESIDE THE BURNER OR TOP OF LIGHTING TUBE - **THEN TURN ON THE GAS** (see Fig. 23-2).

SHUTTING OFF THE GRILL

To shut off the grill, push in each valve control knob and turn it clockwise to the **OFF** position.

Always close the valve to the gas supply after each use of the barbecue.

ALLUMER DES INSTRUCTIONS (D'ALLUMAGE)

Lisez l'instruction entière avant que s'allumant et suivez ces instructions chaque fois vous lumière le barbecue.

ÉCLAIRAGE ÉLECTRONIQUE

Note: Le barbecue doit être relié au courant électrique pour l'éclairage électronique.

1. Ouvrez tous les couvercles et enlevez toutes les couvertures.
2. Arrêtez tous les boutons de commande de gaz à leurs positions.
3. Allumez le gaz à sa source.

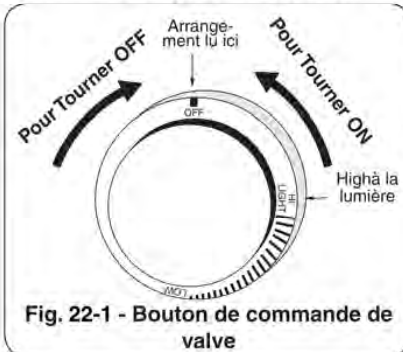

Note: N'ouvrez pas plus d'une valve à la fois pour l'éclairage électronique ou manuel.

4. Appuyez sur et jugez le bouton d'ignitor le plus proche le bouton de commande pour que le brûleur soit s'est allumé. Continuez à se tenir dans le bouton d'ignitor pendant 5 secondes. Le bout de l'ignitor rougeoiera orange. Continuez à tenir le bouton d'ignitor tout en enfonçant le bouton de commande et en tournant le bouton dans la position **HI LIGHT**. Une fois que le brûleur s'allume, libérez le bouton d'ignitor.

ATTENTION: Si les brûleurs ne s'allument pas dans 5 secondes d'allumer le bouton de commande, enfoncez le bouton et tournez-l' à la position de repos. ATTENDEZ 5 MINUTES avant de répéter l'étape 4. Si vous sentez le gaz, suivez les instructions sur la couverture de ce manuel. Si les brûleurs ne s'allument toujours pas après que plusieurs tentatives, se rapportent aux instructions pour l'éclairage manuel.

5. Répétez l'étape 4 pour que chaque brûleur additionnel soit s'est allumé.

Important: En allumant le brûleur sous le tiroir de flavor/smoker, enlevez d'abord le tiroir de sorte que le brûleur puisse être facilement vu. Remplacez alors le tiroir après que le brûleur soit se soit allumé.

POUR LE PROPANE SEULEMENT

Les réservoirs de propane sont équipés d'un dispositif d'arrêt de sûreté qui peut ne pas causer le bas ou aucun gaz pressure/flame aux brûleurs si le fonctionnement et allumer des instructions ne sont pas suivis exactement.

AJUSTEMENT DE LA FLAMME

Les boutons sur le visage du barbecue commandent les valves et ajustent la taille de flamme. La première position marquée est **OFF**, la deuxième **HI LIGHT**, et le troisième **LOW**. Entre la **HI LIGHT** et les **LOW** étiquettes sont les marques de point médian. La taille de flamme peut être placée n'importe où entre la **HI LIGHT** et les **LOW** arrangements.

La taille de la flamme avec une valve en **LOW** position peut être encore réglée à l'aide d'une petite vis de réglage au centre de la tige de valve. Cette vis est accessible en enlevant le bouton de valve, qui tire immédiatement l'extrémité de la tige de valve.

ÉCLAIRAGE MANUEL

ATTENTION: Attendez toujours 5 minutes le gaz à l'espace libre après que n'importe quelle tentative non réussie d'éclairage.

1. Suivez les étapes 1 à 3 (à gauche).
2. Passez un allumeur brûlant de butane de long-baril ou une allumette brûlante de long-tige dans les grilles à cuire au dessus du tube d'éclairage. (Fig. 22-2). Pour des backburners, tenez la flamme contre le matériel perforé du backburner. Pour des sideburners, tenez la flamme contre le brûleur.
3. Tout en tenant l'allumette ou la flamme plus légère à côté du brûleur ou le dessus du tube d'éclairage, enfoncez le bouton approprié de valve et tournez-le dans le sens contraire des aiguilles d'une montre dans la position **HI LIGHT**. Le brûleur s'allumera.
4. Si le brûleur ne s'allume pas, enfoncez **immédiatement** le bouton et tournez le bouton de commande de brûleur à **OFF**. ATTENDEZ 5 MINUTES avant de répéter les étapes 2 à 4 des INSTRUCTIONS MANUELLES d'ÉCLAIRAGE.

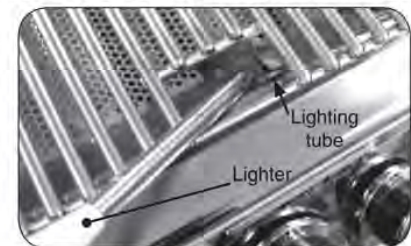

RAPPELEZ-VOUS: POUR L'ÉCLAIRAGE MANUEL SÛR, PLACEZ Un ALLUMEUR BRÛLANT D'ALLUMETTE OU De BUTANE PRÈS Du BRÛLEUR - ALLUMEZ ALORS Le GAZ (voyez Fig. 22-2).

EN COUPANT LE GRIL

Pour couper le gril, enfoncez chaque bouton de commande de valve et tournez-le dans le sens des aiguilles d'une montre à la position de **OFF**. Fermez toujours la valve à l'offre de gaz après chaque utilisation du barbecue.

MAGNUM BARBECUING TIPS

The art of barbecuing involves learning the nuances of your barbecue and knowing how various cuts of meat and other foods cook on it under different settings and conditions.

Each barbecue will be unique due to its configuration and how it is positioned or installed. This section contains information about how Magnum barbecues were engineered, which will help you in learning how your barbecue responds to the way you use it.

COOKING ZONES

Your barbecue is divided into three cooking zones, each corresponding to a main burner. Burners are numbered starting at one (1) on the left, going to three (3) on the right (see Fig. 24-1).

Each cooking zone is designed to be controlled individually. There will be some sharing of heat between zones, but overall heat will tend to reduce slightly at the zone borders.

Specific zones are better suited to specific types of cooking because of features such as being adjacent to a fire wall or away from the smoker drawer.

GRILL HEAT DISTRIBUTION - MAIN BURNERS

The heat level at each part of the grill has been engineered for specific purposes. Knowing the heat distribution for each burner will allow you the best possible food positioning when grilling.

CAUTION: Even the coolest part of the grill is too hot to be touched during operation of the barbecue.

The front of the grill is designed, for safety reasons, to be the coolest part of the grill. If you look directly down on the grill top, while it is off and cool, you can see this portion of the grill, where the front end of each burner stops and the slope of the inner barbecue fire wall begins. This area also loses heat most rapidly when the oven lid is opened (see Fig. 24-2).

From the front of the grill moving toward the back, the heat rises gradually until just above the burner's front edge, where it rises rapidly to a fairly even temperature reflected by the digital thermometer. The heat continues to rise gradually until it reaches a maximum directly above the place where the two lobes

of each burner connect (see Fig. 24-2). From there to the back of the grill, heat diminishes moderately. This supports the desired temperature for the warming rack and prevents heat from becoming excessive at the back fire wall of the barbecue.

GRILL HEAT DISTRIBUTION - IR BURNER

Infrared burners are designed for even, searing heat across their whole surface. Because the heat is radiant, it tends to heat the food you are cooking directly without heating the air around it as much as a conventional burner.

SMOKER DRAWER USE

When using a single cooking zone with the smoker drawer, use zone 1. It will minimize burner heat on the flavor drawer and maximize a circulating convection current that will draw the smoke flavor into the food.

WIND CONSIDERATIONS

Wind direction can have an effect on the barbecue, especially with the oven open. For maximum stability and convenience, position the barbecue so that the oven opens toward any prevailing wind (Fig. 24-1).



SETTING AND USING YOUR DIGITAL THERMOMETER

Your barbecue comes with a three (3)-zone digital thermometer with timer.

The thermometer is located on the face of the barbecue between the control knobs for the first and second cooking zones.

COOKING ZONES

Your barbecue is divided into three cooking zones, each corresponding to a main burner.

Burners are numbered starting at one (1) on the left, going to three (3) on the right. The temperature sensor on each burner has a range of 212-932°F. The meat probe (range 104-212°F) is displayed as zone P in the lower left of the thermometer display.

Temperatures above the upper range are displayed as all dashes.



Fig. 25-1

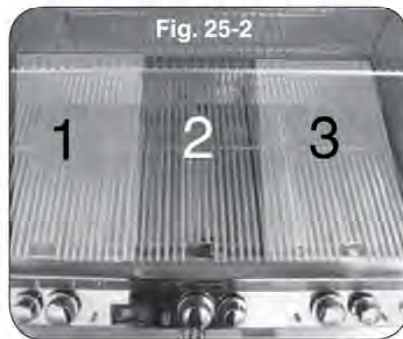

Fig. 25-2

TURNING THE THERMOMETER ON AND OFF

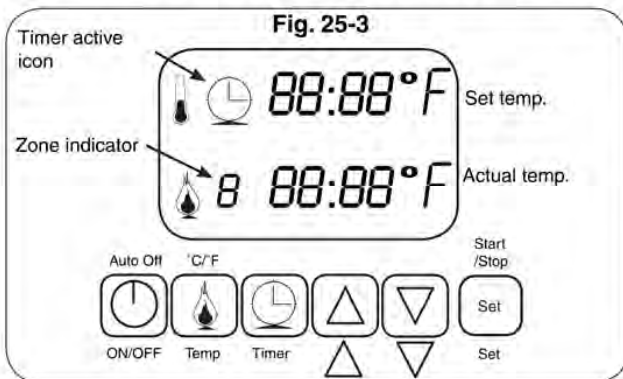



Fig. 25-3



To turn the thermometer on when it is off, or off when it is on, press and release the  **ON/OFF** button. The thermometer backlight will stay on for five (5) seconds after any button is pressed and released.

The thermometer has an automatic shutoff feature that engages after five (5) or 10 minutes of low temperature readings.



Note: Temperature and timer alarms will not sound when the thermometer is off.

MONITORING TEMPERATURE

Your thermometer displays the currently set alarm temperature over the current actual temperature (see Fig. 25-3) for one zone at a time. By default the thermometer is in scan mode and will cycle through each of the zones repeatedly. To stop the timer in any one zone, press and

release the **Temp**  button while in that zone. Press **Temp**  again to return to scan mode.

To change the readings from the Fahrenheit scale to Celsius, depress and hold the temperature button for three (3) seconds until the display blanks (except

for either a "C" or "F.") Then use the up  or down  arrow to change the units. Press **Temp** button again to return to temperature monitoring mode. Temperature values will automatically be converted to the new units.

SETTING THE ALARM TEMPERATURE IN A ZONE

To set the alarm temperature for the currently displayed zone:





1. Press and release the  button.
2. Repeatedly press the up  or down  arrow button to change the value of the blinking digit in the set temperature.
3. Press and release the  button again to make the next digit blink.
4. Repeat steps 2 and 3 until the alarm temperature you wish to set is displayed and the temperature numbers no longer blink. Setting a temperature outside the zone's range will cause ERR to flash on the display.
5. Press the  button again to return to temperature scan mode.







Fig. 25-4



SETTING AND USING YOUR DIGITAL THERMOMETER (Cont.)

Note: While the thermometer is scanning through the zones, if the temperature for the currently displayed zone exceeds the set alarm temperature, an audible alarm will sound and the flame icon will flash. No alarm will sound for a zone that is not being displayed.

SETTING THE TIMER

To set the independent timer alarm, press and release the **Timer** button so that the current timer interval is displayed in H:MM format, where "H" is hours and "MM" is minutes.

1. Press and release the  button to select the minutes place. Both digits to the right of the colon will blink.
2. While the digits to the right of the colon are blinking, press and release the  up/down  arrows repeatedly to change the minutes place. Press and hold to rapidly scan through available values.
3. Press and release the  button again to set the hours place. The digit to the left of the colon will blink.

4. While the digit left of the colon is blinking, press and release the  up/down  arrows repeatedly to set the hours place. Press and hold to rapidly scan through available values.

5. Press and release the **Timer** button  again to set the timer interval.

6. Press and release the **Set** button  to start the countdown timer. The timer icon will appear, indicating the timer has been activated. The timer can be suspended by pressing the **Set** button again while in this mode.

Note: When the timer interval has elapsed, an audible alarm will sound. Press any button to silence the alarm.

7. Press  again to return to the temperature display.



Note: Temperature and timer alarms will not sound when the thermometer is off.

The digital thermometer is powered by two (2) double-A (AA) batteries (included). The battery holder is located on the right side of the faceplate below the meat probe rack and plug. Use alkaline batteries for best results (Figs. 26-1, 26-2).

REPLACING THE BATTERY

1. Remove the meat probe from its hanger and set it aside.
2. Use your fingernail to pull the top of the battery tray door away from the barbecue.
3. Hold the exposed battery holder tray with two fingers and lift it up slightly at the base so that it lifts up out of the locked position and pulls freely outward.

Note: You may now release the battery tray, as it will hang out of the barbecue on two stops.

4. Remove old batteries. Install new batteries.
5. Place the battery holder tray back into the barbecue (Fig. 26-1).
6. Push the bottom of the battery holder door in until it locks back into place and the door is once again flush against the side of the barbecue face.

USING THE MEAT PROBE

The meat probe for zone "P" of your digital thermometer plugs into the right side of the barbecue faceplate.

1. Plug the mini-jack side of the meat probe into the plug on the right side of the barbecue face (Fig. 26-2, top).
2. Insert the probe into the meat to be monitored.
3. Set the probe temperature as desired, following the digital thermometer instructions.
4. When finished, slide the meat probe into the hanger on the right side of the barbecue face.

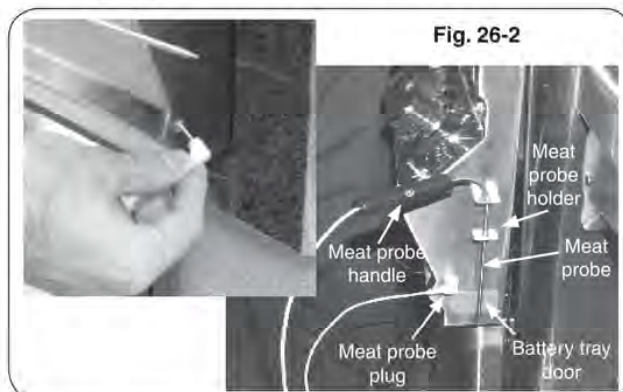

Important: Do not put the meat probe directly into flame.

USING THE INFRARED BURNER (OPTION)

The Fire Magic® infrared searing burner (optional) cooks with a powerful radiative heat that is different from conventional convection cooking by flame.

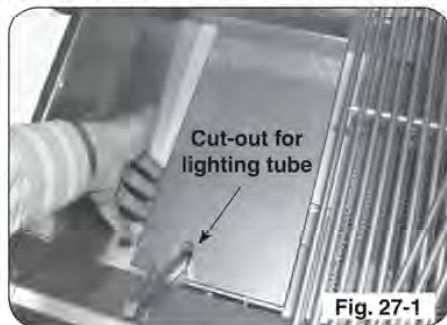

Although lighting the infrared burner is virtually identical to lighting a traditional gas burner (see LIGHTING INSTRUCTIONS in this manual), there are some differences after that point. Allow yourself time to become accustomed to cooking with the power and convenience of the infrared gas burner while following these simple and useful guidelines.

Always allow the infrared burner to heat completely (it will glow orange) before placing food on the grill above it. This way, any drippings from your food will evaporate on contact with the ceramic portion of your infrared burner rather than clogging and impairing its function, which can happen if grease or other material gets into the ceramic matrix.

Because the radiated heat emanating from the infrared burner is so intense, stay with the food while cooking and check it often. Infrared cooking is most frequently used to sear the outside of a cut of meat. Consider something like two (2) or three (3) minutes on a side or less depending on the size of the cut and how dark you like it. Once the meat is seared, it can be cooked on the grill over a conventional burner until the internal temperature is at the desired level with all of the delicious juices locked inside. If you wish to cook food on the infrared burner exclusively, consider reducing the heat and turning the food often.

Always keep your infrared burner covered when not in use, especially when cooking with the other burners in your Fire-Magic® barbecue. This will keep grease, dust, food, and other foreign material out of the ceramic portion of your infrared burner. Remove knock-outs if necessary to fit the cover over lighting tubes or ignitors.

CAUTION: Do not strike or scrape the ceramic portion of the burner with hard tools, as the material may crack, chip or break. Prevent any grease, water, or

other foreign material from getting into the ceramic portion of the burner, especially when it is cold. Always wait for the burner to heat up to a well-distributed orange glow before placing food on the cooking grid above it. When the burner is at temperature, it will vaporize small amounts of grease that drip on it. Always cover the burner when not in use. Keeping the ceramic portion of the burner free of foreign substances will allow the gas to circulate and burn over the entire heating surface, allowing for powerful and even cooking over the life of the burner.

Should your burner become dirty or clogged be careful cleaning it with any standard non-abrasive, acid-free cleaner. The ceramic is delicate and can be chipped or cracked if excessive or concentrated force is used.



WARNING

Only manipulate the infrared burner cover when the grill is cold or with a well-insulated long-handled tool, gloves, or other means to protect your hands and arms.

REMOVING THE SEARING BURNER LID

Observing the above warning, lift the lid upward off the burner, holding both sides, until the cover clears the lighting tube in the front.

COVERING THE SEARING BURNER

Observing the above warning, set the lid down with the cut-out forward and over the lighting tube in the front of the barbecue. Then let the cover come to rest on top of the burner grate with the left and right sides fitting down over the outside of the burner, but the front and back sides of the lid resting on the top of the burner.

ROTISSERIE INSTRUCTIONS

USING YOUR BACKBURNER AND ROTISSERIE

Rotisserie cooking with the backburner is accomplished without use of the main burners. Follow the steps in the appropriate sections below to set up and use these accessories (see PARTS LIST for image).

SET UP

1. Remove the warming rack and backburner cover (if present) by sliding it upward off the backburner.
2. Remove the cooking grids from your barbecue (if necessary) to obtain maximum clearance for larger cuts. The flavor grids may also be removed if required for clearance.

Tip: Aluminum foil or a baking pan may be placed over the main burners, a little forward of center, to catch excess drippings from the meat on the rotisserie.

3. Attach the rotisserie motor to the rotisserie mounting on the right side of your barbecue by inserting the four (4) mounting tabs through the four (4) holes in the motor mounting on the right side of the barbecue and allowing the unit to slide downward and lock into place.

Note: Orient the motor as shown in the PARTS LIST.

4. Follow the LIGHTING INSTRUCTIONS to light the backburner.
5. Allow the backburner to preheat for approximately 10 minutes on **HI LIGHT** setting.

PUTTING THE MEAT ON THE SPIT ROD

1. Slide the meat and spit prongs onto the spit rod so the meat is centered and balanced as well as possible.
2. Tighten the spit prongs into place so that the meat remains in a fixed position on the rod and the meat rotates with the rod.

Important: The counterbalance, which is included with your rotisserie kit, should be used to balance the load on your rotisserie and prolong the life of your motor. Heavy unbalanced meats can stress the rotisserie motor and may cause motor failure.

USING THE COUNTERBALANCE SUPPLIED WITH YOUR ROTISSERIE

1. Hold the spit rod at each end and lift. **Do not grip the rod.** Let the rod rotate so the heavy side of the meat hangs down naturally.

2. Turn the counterbalance on the spit so the counterbalance rod and weight point upward, or opposite from the heavy side of the meat. Tighten the counterbalance rod in the hub against a flat surface of the spit rod to secure (Fig. 28-1).

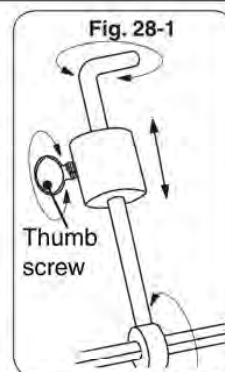

3. Loosen the thumb screw and slide the weight along the counterbalance rod to balance the meat. Since meats are not a uniform shape, it may not be possible to achieve a perfect balance. Properly balanced meat should not rotate when you hold the spit rod loosely by the ends.
4. Make sure the counterbalance will not strike the barbecue frame when the rotisserie is started.

USING THE ROTISSERIE

1. Place the pointed end of the spit rod into the motor drive socket and rest the handle end of the spit rod in the spit bracket on the right side of the barbecue.
2. Plug in and turn on the rotisserie motor.
3. Use a standard roasting guide to estimate the length of time for your meat. The digital thermometer meat probe may also be used to tell when your favorite cuts are cooked to your liking. When checking temperatures with the thermometer, turn off the rotisserie motor and turn the backburner on **LOW**. This will keep the meat from overcooking on one side.

Note: When burning properly, the backburner flames will be blue with yellow tipping, and the grating will glow red. The first time it is used, the backburner may smoke a little for a few minutes. This is normal.

Important: Operate your backburner with the oven closed. This simulates an oven effect and helps your meat cook faster. Constant rotation of the spit ensures even cooking and maximum retention of juices.

Note: On large cuts of meat or whole turkeys, it may be necessary to reduce the heat from your backburner. Cooking your food at a lower temperature for a longer period of time will keep the outer surface from burning while cooking the interior of your meat. In any case, it is normal for the backburner grating to glow red when operating properly.

ACCESSORIES

THE GRILL BRUSH

Purchase a Fire Magic® stainless-steel grill brush (sold separately) to keep your grill clean. It comes with a scraper for large particles and a replaceable head with brass bristles for overall cleaning.



Fig. 29-1
Grill brush with replacement head

THE COOKING GRID LIFTER

Hold the grid lifter by gripping the center section with the prongs pointing down (use an oven mitt or heavy glove if the grill is hot). Insert the notched end of the grid lifter into the cooking grid, in front of the midway point (front to back; Fig. 29-3), and central (left to right; Fig. 29-4). Twist the grill lifter (clockwise or counterclockwise) so the handle is parallel to the grill rods. This “seats” the spiked end of the grid lifter between two rods, enabling you to safely lift the grid out of the barbecue. Lift slowly and adjust the grid lifter, if necessary, for balance.

THE DRIP PAN

The drip collection system allows you to brush or scrape excess dried residue inside the barbecue directly into the drip pan (see PARTS LIST for drip pan location). To simplify cleanup when using the rotisserie, you may place a baking pan or foil under the rotisserie on top of the burners to collect the drippings. Clean the drip pan after each use.

THE FLAVOR GRID(S)

Place each flavor grid directly on a burner or burner pair. Center each grid over the burner, oriented as shown in Fig. 29-6.

Note: This allows heat from the burners to be evenly distributed throughout the cooking area. The flavor grids heat and cool quickly, making the barbecue very responsive to changes in heat from the burners.



Fig. 29-5
Wood chip smoker drawer



Fig. 29-6

THE WARMING RACK

The warming rack (Fig. 29-2) is packed separately with the barbecue.

To install the warming rack, lift the front of the rack up slightly and insert the rack hangers into the two holes in the back of the barbecue above the backburner. Then lower the front of the rack into a level position to lock the rack in place.

To remove the warming rack, lift up on the front of the rack until the rack hangers pull free from their supporting holes.

Note: Removing the warming rack before using the rotisserie will leave more clearance for the meat being cooked.



Fig. 29-2 Warming rack in place inside oven



Fig. 29-3



Fig. 29-4

Placement of the grill lifter in grill

FLAVOR FROM WOOD CHIPS OR CHARCOAL

You can add wood chips, wood chunks, or the natural wood charcoal of your choice to the flavor drawer (Fig. 29-5) or the flavor grid (Fig. 29-6). Heat wood chips in the flavor drawer by lighting the smoker burner using the smoker control and zone 2 ignitor. When using the flavor grid, we recommend placing wood outside the direct cooking zone or wrapping it in perforated aluminum foil. Soaking wood before use will slow burning and increase smoke flavor. Wood and charcoal ash will remain in the flavor grid and drawer after use. Either can be easily removed and cleaned when the unit has fully cooled. The flavor drawer is water-tight, allowing liquid flavorings to be added as well.

BARBECUE CARE & CLEANING

CARE AND CLEANING

Your new Fire Magic® barbecue represents the latest and most advanced technology available. In order to continue to enjoy the benefits of this technology and to protect your investment, we recommend the following:

Cover your barbecue with a Fire Magic® cover when not in use.

Clean it with a quality stainless-steel cleaner at least once a month (see Fig. 30-1).

Note: Due to the nature of 304 stainless steel, iron oxide deposits may appear. Do not be alarmed – these deposits are removable with stainless-steel cleaner through periodic maintenance.

Check and clean the burner ports at least annually for blockage by removing the burner (see orifice changing instructions) and visually inspecting the burner inlet for insects and nests. A clogged burner can lead to a fire beneath the grill.

The inside of the barbecue may be cleaned periodically with oven cleaner if desired. Follow the oven cleaner instructions for proper use.

By following these recommendations, you will enjoy the beauty and power of your barbecue for many years to come.



Fig. 30-1 - Wipe with grain

BARBECUE COVER

PROTECTING YOUR BARBECUE

An optional heavy-duty cover will protect the finish on your barbecue and preserve your investment. The water-repellent material will shield your barbecue from corrosion and oxidation.

To provide a custom fit, each cover has been cut and sewn by hand for a particular smoke oven model. Make sure to give the model number of your barbecue when ordering a cover from the manufacturer or your local dealer.

To maintain and protect your barbecue cover, occasionally wipe the outside with a sponge soaked

in water and a mild household detergent or cleaner, and rinse with a clean damp cloth.

Important: Allow your barbecue to cool before covering.

Important: Always close the gas-supply shutoff valve to the barbecue. If storing the barbecue for a long period of time, disconnect the barbecue from the gas supply completely.

Always check the burners before using the barbecue if it hasn't been used in a while. Look for obstructions that may hamper performance and safe operation of your barbecue.



Fig. 30-2

MAGNUM ELECTRICAL MAINTENANCE

Magnum barbecues are all engineered with the conveniences of electrical power for illuminating and igniting the grill.

To replace any Magnum oven light, follow the instructions below.

WARNING

To protect from potentially sharp sheet metal and glass, wear gloves and safety glasses during this procedure.

1. Turn all burner control knobs to the **OFF** position and shut off the gas supply to the barbecue at the source (tank valve for propane units or gas line on shutoff valve for natural-gas units.)
2. Disconnect supply of external electrical power to the barbecue.

CAUTION: Wait for the barbecue, oven, lens, light bulb, and fixture to cool before proceeding to the next step.

3. Open the oven lid.

Important: Place one hand directly below the glass lens and prepare to catch it when it is detached.

4. Carefully insert a standard flat-head screwdriver or thin plastic spatula between the glass lens and the stainless steel on which the light is mounted



and gently pry the glass lens out in such a way that the stainless steel is not scratched (twisting the screwdriver handle, for instance). Catch the lens and set it safely aside.

Note: You may wish to take this opportunity to clean the lens with a standard household window cleaner and then dry it completely.

5. Wearing a pair of gloves, reach into the fixture, gently grab the bulb, and pull it straight out of the fixture so that the two pins at the base of the bulb come all the way out.

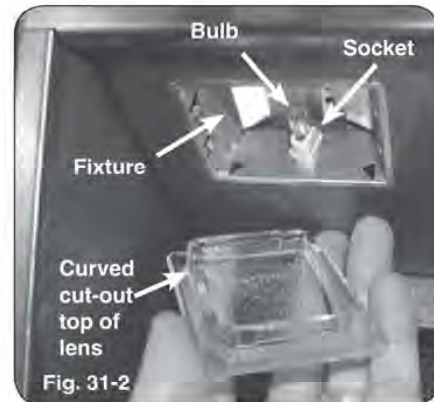

Important: Bulb is halogen. DO NOT TOUCH with bare hands. Oils from hands drastically reduce bulb life.

Note: It may be helpful to rock the bulb gently backward and forward while pulling it out.

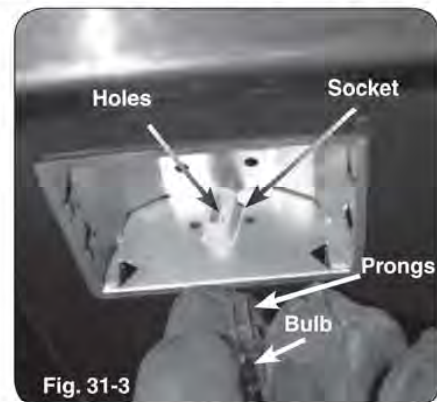

6. Inspect the old bulb for broken glass or filament.

Note: It may be beneficial to test a suspect bulb in one of the other light fixtures known to be working and turn the power back on to be certain the bulb is actually not working.

7. Insert the new bulb into the socket so that both pins slide all the way into the two holes in the bottom of the socket.
8. Place the lens back into the fixture opening with the curved cut-out on the bottom and snap it back into place.

TROUBLESHOOTING

If you have trouble with this Fire Magic® barbecue, please use this list to identify the problem. By trying one or more of the solutions to the possible cause, you should be able to solve the problem. If this list does not cover your present problem, or if you have other technical difficulties with the barbecue, please contact your local Fire Magic® dealer or visit our web site at www.rhpeterson.com.

PROBLEM	POSSIBLE CAUSE	CORRECTION
Ignition system failure	1. Power source not hooked to power supply 2. Improper air shutter adjustment 3. Ignition wire disconnected 4. Low gas pressure 5. Front carry-over port	1. Hook external power to barbecue. 2. Adjust air shutters. 3. Plug wires back into ignition switches. 4. Have the gas co. check pressure at barbecue. 5. Clean burner ports.
Insufficient heat	6. Improper air shutter adjustment 7. Using propane orifice for natural gas 8. Low gas pressure/flame (propane) 9. Low gas pressure/flame (natural)	6. Adjust air shutters. 7. Check/change orifices. 8. Shut off all valves, including propane tank, and follow lighting instructions exactly. (See important note* below.) 9. Have the gas co. check pressure at barbecue.
Uneven heating	10. Burner ports partially blocked by debris 11. Small spiders or insects in burner 12. Improper air shutter adjustment	10. Remove burners and clean out ports. 11. Inspect burners and orifices for spider webs or other debris that may block flow. 12. Adjust air shutter.
Thermometer malfunction	13. Battery charge low	13. Replace batteries. Check connections to batteries.
Rotisserie noisy	14. Rotisserie out of balance	14. Adjust rotisserie counterbalance.

Table 2

*** Important:** Propane tanks are equipped with a safety shutdown device that may cause low or no gas/flame at the burners if operating and lighting instructions are not followed exactly. If you suspect the propane tank safety shutoff is in effect, shut off all burner control valves and the propane tank valve. Then read and follow the LIGHTING INSTRUCTIONS exactly. Lighting instructions are located in your owner's manual and printed on the barbecue's metal drip tray. If the problem persists, continue troubleshooting, or contact your local dealer or R. H. Peterson for assistance.

CONVERTING THE GAS SUPPLY

This Fire Magic® barbecue comes from the factory configured for one type of gas as marked on the label behind the barbecue face.

Conversion orifices and a label are included with your barbecue's conversion kit. The professional installer who converts this barbecue to burn a different gas must perform the following functions:

1. Change replaceable brass gas orifices on each burner (included at original shipping) to match the new gas type (see Table 1).
2. Switch the convertible gas regulator (included at original shipping) to match the new gas type (see below).
3. Natural-gas to propane-gas conversions using a tank internal to a portable barbecue require installation of a propane tank holder (not included with conversion kit) for safety and compliance with the ANSI standards referenced on the cover of this document. This tank holder must be purchased separately from the manufacturer.
4. Plumb the unit to the new gas supply.
5. Apply the new label behind the face indicating the new gas the barbecue will burn (included with conversion kit). The label must be applied on top of the old label so that it covers the old gas type and ratings information but not the serial number and other unchanged data.

WARNING

HAZARDOUS OVERHEATING WILL OCCUR IF A NATURAL-GAS ORIFICE IS USED WITH PROPANE GAS. IF YOU ARE NOT SURE THE CORRECT ORIFICES ARE INSTALLED, OR IF AN ORIFICE CHANGE IS NECESSARY, REFER TO THE INSTRUCTIONS ON THE FOLLOWING PAGES.

CAUTION: Make sure the barbecue is at a safe temperature and isolated from gas and electrical supplies before beginning the tasks outlined in the following pages.

CAUTION: Use adequate hand protection, such as gloves, when handling potentially sharp sheet metal parts.

CHECKING/CONVERTING THE BARBECUE REGULATOR

WARNING

THIS APPLIANCE REGULATOR IS RATED FOR 1/2 PSI MAXIMUM. IF YOUR GAS SUPPLY IS GREATER THAN 1/2 PSI, AN ADDITIONAL REGULATOR MUST BE INSTALLED BETWEEN THE BARBECUE AND GAS SUPPLY. SEE SECTION ON *GAS-SUPPLY REQUIREMENTS* FOR PROPER GAS-SUPPLY PRESSURE.

The barbecue regulator, located behind the front panel (face), must be set for the type of gas used to fuel the barbecue. To check the regulator setting, remove the cap in the center of the regulator (Fig. 33-1). Holding the cap vertical (see Fig. 33-2), the letters at the bottom of the plastic stalk should indicate the gas type for which the regulator is currently set up. If the regulator is not set for your gas type, remove the stalk from the cap, invert, and replace into center of cap. Replace cap on the regulator, screwing down until snug.

Barbecue Regulator
Note the cap on top.



Fig. 33-1



Read gas
type here.
(LP shown)
Fig. 33-2

CHECKING/CONVERTING THE BARBECUE GAS TYPE (Cont.)

GAS ORIFICE CHECKING/CONVERSION

This Fire Magic® barbecue comes from the factory configured for one type of gas as marked on the label behind the barbecue faceplate.

Each burner has a brass orifice, which can be replaced and must match the gas being used. When converting the barbecue to a different gas, each burner's orifice must be replaced with the corresponding orifice for the new gas.

Consult Table 1 at the beginning of this document to determine the proper orifice sizes for each burner.

It is critical to the operation of each burner that its orifice be fully inserted into the center of its orifice opening.

WARNING

Hazardous overheating will occur if a natural-gas orifice is used with propane gas. If you are not sure the correct orifices are installed, or if an orifice change is necessary, refer to the following instructions.

CAUTION: Make sure the barbecue is at a safe temperature and isolated from gas and electrical supplies before beginning the tasks outlined below.

For your safety, exercise caution, and make sure you have adequate hand protection, such as gloves, when handling removable sheet metal parts of the barbecue.

CHANGING THE MAIN BURNER ORIFICES

Suggested tools:

- a pair of needle-nose pliers
- a deep $\frac{3}{8}$ " nut driver or socket wrench

1. Remove the grill from above the burner you are working on by lifting it first from the front and set it aside.
2. Remove the flavor grid from above the burner you are working on and set it aside.
3. Remove the cotter pin from the right rear burner anchoring peg by pulling it straight out of the cotter pin hole using needle-nose pliers.

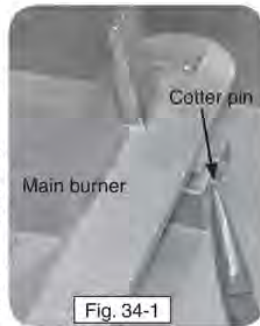

CAUTION: The burner is heavy.

4. Lift the back end of the burner out of the anchor peg holes, then move the burner toward the back of the barbecue and set it aside.
5. Use a nut driver to remove the exposed orifice (see Fig. 34-2) and replace it with the correct orifice for the new gas. (See Table 1 at the beginning of this

document for correct orifice sizes based on burner type and gas type.)

6. Replace the burner by first sliding the open round end, enveloping the burner orifice with the open rounded mouth of the burner, and then lowering the back end anchor pegs into the anchor peg holes.

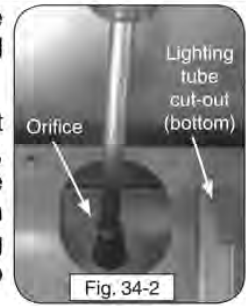

- Note:** It is critical to the continued safe functioning of the burner that the orifice is centered and completely inside the burner gas conduit.
7. Reinsert the cotter pin into the right rear burner anchor peg using needle-nose pliers.
 8. Replace the flavor grid and then the grill so that the cut-out section of the grill is lined up with the lighting tube.

Repeat these steps for each main burner.

CHANGING THE BACKBURNER ORIFICE

Suggested tools:

- a Phillips-head screwdriver (#2 medium)
- a $\frac{3}{8}$ " nut driver or socket wrench

1. Remove the warming rack (if installed) and set it aside.
2. Remove the backburner cover.
3. Unscrew all backburner faceplate screws using a Phillips-head screwdriver and set them aside.
4. Remove the backburner faceplate by pulling the bottom toward the front of the barbecue and rotating it upward and outward until the two top tabs can be removed from the back wall of the barbecue. Set it aside.
5. Remove the backburner assembly retaining screw on the lower left of the backburner using a Phillips-head screwdriver and set it aside.
6. Pull the backburner assembly to the left, clear of the orifice, and then rotate the top forward and downward and lay it face down across the main burner dividers.



CAUTION: Be careful not to damage the wires connected to the backburner assembly.

7. Use the socket with appropriate driver to remove the exposed orifice and replace it with the correct orifice for the gas being converted to. (See Table 1 for correct orifice size for this burner based on gas.)
8. Replace the backburner assembly and reinsert the retaining screw. Center the backburner assembly so that the backburner faceplate will fit over it. Tighten the retaining screw using a Phillips-head screwdriver.

CHECKING/CONVERTING THE BARBECUE GAS TYPE (Cont.)

- Replace the backburner faceplate by first inserting the upper tabs into the slots in the back wall of the barbecue and then rotating the bottom downward and inward.



- Replace all the backburner faceplate screws using a Phillips-head screwdriver.

Note: It is critical to the continued safe functioning of the burner that the orifice is centered and completely inside the burner gas conduit.

CHANGING THE SMOKER DRAWER BURNER ORIFICE

Suggested tools:

- a 1/4" hex nut driver
- a 7/16" wrench
- a 5/8" box wrench

- Remove the burner control knobs from the face by pulling them gently away from the face. Set them aside.
- Pull the smoker drawer completely out of the front of the barbecue and set it aside.



- Release the face from the front of the barbecue by unfastening the screws (Fig. 35-2) on its face with the Phillips-head screwdriver. Then move the face to the right until it clears the "lid closed" switch on the upper right side of the face. Next, lift upward and tilt outward until the face rests against the support chain.

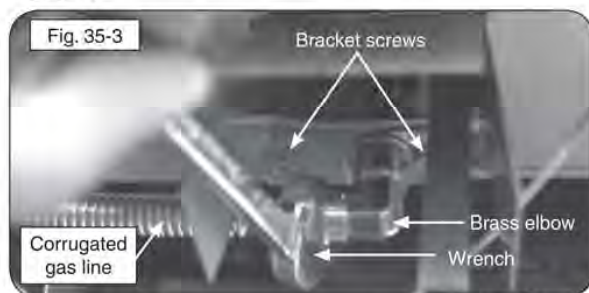

- Locate the smoker drawer orifice bracket behind the face on the right side and remove the compression fitting that connects the corrugated aluminum gas line to the back of the brass elbow projecting out from the bracket using a 5/8" box wrench (Fig. 35-3).

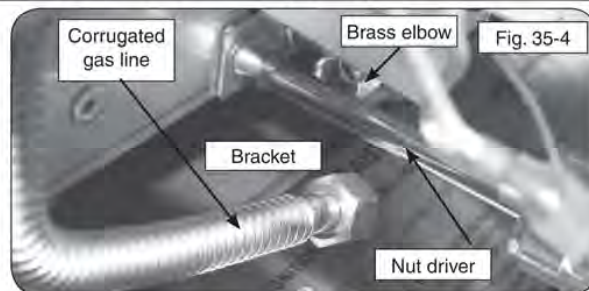

- Remove both hex nut screws from the flavor drawer orifice assembly bracket using the 1/4" nut driver (Fig. 35-4).

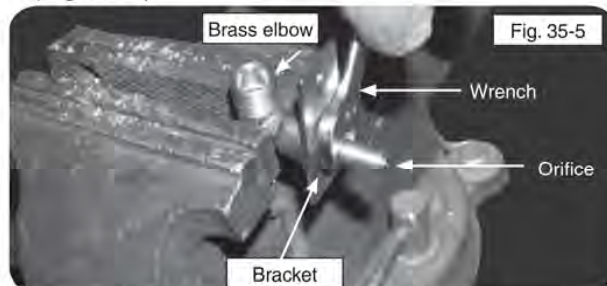

- Remove the bracket and orifice assembly from the barbecue and use two wrenches to loosen the orifice from the elbow. Use a 7/16" wrench with the orifice and a small adjustable wrench or crescent wrench to grip the brass elbow (Fig. 35-5).
- Once the orifice has been removed, replace it with the new orifice and retighten the orifice assembly with a 7/16" wrench while placing the washers and bracket and elbow in their original positions and orientations.
- Fasten the smoker drawer orifice bracket assembly back into place with the orifice opening pointing toward the back of the barbecue and inserted into the open end of the burner on the other side of the fire wall. Use both original hex nut screws and the 1/4" nut driver.

Note: If you bent the metal guides to gain easier access to the hardware, bend them back.

- Reconnect the corrugated stainless-steel gas hose to the brass orifice assembly elbow by rethreading and tightening the compression fitting with the 5/8" box wrench.

Important: Check for gas leaks using a soap and water solution. Never test for leaks using a flame.

- Replace the barbecue face and knobs.
- Reinsert the smoker drawer from the front of the barbecue.

CHANGING AN INFRARED BURNER ORIFICE (IF EQUIPPED)

Suggested tools:

- a pair of needle-nose pliers
 - a 1/4" hex nut driver
 - a 3/8" hex nut driver
1. Remove the grill from above the burner you are working on by lifting it first from the front and set it aside.
 2. Remove the lighting tube by removing the two hex nut screws using the 1/4" hex nut driver. Set the screws and tube aside.
 3. Remove the infrared burner by lifting the back of the burner up so that both tabs are freed from their slots, then lift the burner toward the back of the barbecue and upward. Set the burner aside.
 4. Use the 3/8" nut driver to remove the exposed orifice and replace it with the correct orifice for the new gas. (See Table 1 for correct orifice sizes based on burner and gas type.)
 5. Replace the infrared burner by first sliding it over the orifice, then lining up the two tabs in back of the burner with the two slots in the back of barbecue and lowering them carefully into place.
 6. Replace the lighting tube using the 1/4" hex nut driver to lightly tighten both hex nut screws.
 7. Replace the grill so that the cut-out section of the grill is lined up with the lighting tube.

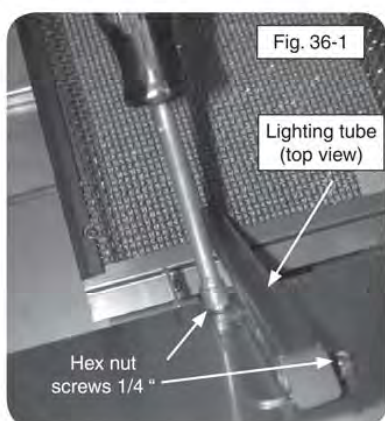

FIRE MAGIC® OUTDOOR GAS BARBECUES LIMITED WARRANTY

PLEASE COMPLETE AND RETURN YOUR REGISTRATION CARD, WHICH IS INCLUDED WITH YOUR BARBECUE

LIFETIME WARRANTY - Fire Magic® cast stainless-steel burners, stainless-steel rod cooking grids, and stainless-steel housings (including liners, frames, ovens, and barbecue faces) are warranted for as long as you own your Fire Magic® barbecue.

FIFTEEN-YEAR WARRANTY - Fire Magic® cast brass burners, brass valves, backburner assemblies (except ignition parts), manifold assemblies, and porcelain hoods and faces are warranted for 15 years from the date of purchase of your Fire Magic® barbecue.

THREE-YEAR WARRANTY - Fire Magic® sideburners and all other Fire Magic® barbecue components (except ignition and electronic parts) are warranted for three (3) years from the date of purchase of your Fire Magic® barbecue.

Fire Magic® ignition systems, electronic components (including lights and thermometers), and barbecue accessories are warranted for one (1) year from date of purchase.

PLEASE KEEP A COPY OF YOUR SALES SLIP FOR PROOF OF PURCHASE

This warranty applies to the original purchaser with invoice or proof of purchase and covers Fire Magic® products intended for personal, family, or household usage only. It does not apply to rust, corrosion, oxidation, or discoloration, which may occur due to moisture or overheating, unless the affected component becomes inoperable. This warranty does not cover parts becoming defective by misuse, accidental damage, improper handling, and/or installation. It does not cover labor or labor-related charges. It specifically excludes liability for indirect, incidental, or consequential damages. Some states do not allow the exclusion or limitation of incidental or consequential damages, so the above exclusion may not apply to you. This warranty gives you specified legal rights, and you may have other rights that may vary from state to state.

For additional information regarding this warranty, or information on how to place a warranty claim, contact your authorized Fire Magic® dealer.

ROBERT H. PETERSON CO.

Quality Check

Date: _____

Orifice # (Main): _____

Orifice # (Other): _____

Leak Test: _____

Burn Test: _____

Gas Type: NAT. / PROPANE

Model #: _____

Serial #: _____

Air Shutter: _____

Inspector: _____

Robert H. Peterson Co. • 14724 East Proctor Avenue • City of Industry, CA 91746